

MODEL PAXLT - PAX LITE TEMPERATURE METER



- 5 DIGIT, 0.56" HIGH RED LED DISPLAY
- DISPLAYS °C OR °F WITH 1° OR 0.1° RESOLUTION
- BACKLIGHT OVERLAYS INCLUDED (°C AND °F)
- MAX AND MIN READING MEMORY
- TC COLD JUNCTION COMPENSATION (ON/OFF)
- PROGRAMMABLE TEMPERATURE OFFSET
- PROGRAMMABLE USER INPUT
- DUAL 5 AMP FORM C RELAYS
- UNIVERSALLY POWERED
- NEMA 4X/IP65 SEALED FRONT BEZEL
- THERMOCOUPLE AND RTD INPUTS
- CONFORMS TO ITS-90 STANDARDS



For Model No. PAXLT0U0 Only

GENERAL DESCRIPTION

The PAXLT is a versatile meter that accepts a variety of thermocouple and RTD inputs and provides a temperature display in Celsius or Fahrenheit. The readout conforms to ITS-90 standards, with 1° or 0.1° resolution. The 5-digit display has 0.56" high digits with adjustable intensity. Backlight overlay labels for °F and °C are included.

The meter features a Maximum and Minimum reading memory, with programmable capture time. The capture time is used to prevent detection of false max or min readings which may occur during start-up or unusual process events. Either value can be displayed if desired. The display can be toggled manually or automatically between the selected values.

Other features include thermocouple cold junction compensation, display offset and a programmable user input to perform a variety of meter control functions. Two setpoint outputs are provided, each with a Form C relay. Output modes and setup options are fully programmable to suit a variety of control requirements.

The PAXLT can be universally powered from a wide range of AC or DC voltage. The meter has been specifically designed for harsh industrial environments. With a NEMA 4X/IP65 sealed bezel and extensive testing to meet CE requirements, the meter provides a tough yet reliable application solution.

SAFETY SUMMARY

All safety regulations, local codes and instructions that appear in this and corresponding literature, or on equipment, must be observed to ensure personal safety and to prevent damage to either the instrument or equipment connected to it. If equipment is used in a manner not specified by the manufacturer, the protection provided by the equipment may be impaired.

Do not use this meter to directly command motors, valves, or other actuators not equipped with safeguards. To do so can be potentially harmful to persons or equipment in the event of a fault to the meter

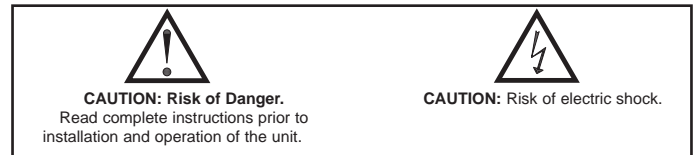

ORDERING INFORMATION

| MODEL NO. | DESCRIPTION | PART NUMBER |
|-----------|---|-------------|
| PAXLT | TC/RTD Temperature Meter with Dual Relay Output | PAXLT000 |
| | UL Listed TC/RTD Temperature Meter with Dual Relay Output | PAXLT0U0 |

SPECIFICATIONS

- DISPLAY:** 5 digit, 0.56" (14.2 mm) intensity adjustable Red LED
- POWER REQUIREMENTS:**
 - AC POWER:** 50 to 250 VAC 50/60 Hz, 12 VA
 - Isolation:** 2300 Vrms for 1 min. to all inputs and outputs
 - DC POWER:** 21.6 to 250 VDC, 6 W
 - DC Out:** +24 VDC @ 100 mA if input voltage is greater than 50 VAC/VDC
+24 VDC @ 50 mA if input voltage is less than 50 VDC
- READOUT:**
 - Display Range:** -19999 to 99999
 - Scale:** °F or °C
 - Resolution:** 1° or 0.1°
 - Response Time:** 500 msec min.
 - Display Overrange/Underrange Indication:** "....." / "-....."
 - Input Overrange/Underrange Indication:** **OL OL** / **UL UL**

DIMENSIONS In inches (mm)

Note: Recommended minimum clearance (behind the panel) for mounting clip installation is 2.1" (53.4) H x 5.0" (127) W.

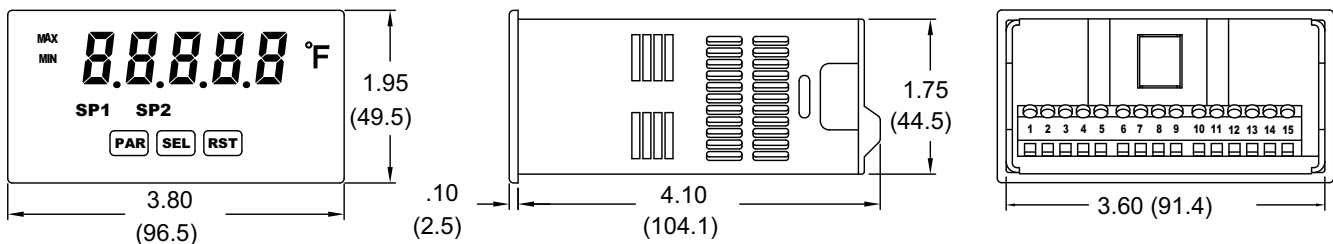

4. **THERMOCOUPLE INPUTS:**

Input Impedance: 20 MΩ

Max. Continuous Overvoltage: 30 VDC

Failed Sensor Indication: *DPE#*

| TC TYPE | RANGE | ACCURACY @ 23°C ±°C * | ACCURACY @ 0 to 50°C ±°C * | WIRE COLOR | |
|---------------|----------------------------------|------------------------|----------------------------|-----------------------|------------------------|
| | | | | ANSI | BS 1843 |
| T | -200 to 400°C -328 to 752°F | 2.3 | 5.8 | (+) blue (-) red | (+) white (-) blue |
| E | -200 to 871°C -328 to 1600°F | 2.7 | 4.9 | (+) purple (-) red | (+) brown (-) blue |
| J | -200 to 760°C -328 to 1400°F | 1.9 | 4.3 | (+) white (-) red | (+) yellow (-) blue |
| K | -200 to 1372°C -328 to 2502°F | 2.3 | 5.8 | (+) yellow (-) red | (+) brown (-) blue |
| R | -50 to 1768°C -58 to 3214°F | 4.5 | 15.0 | no standard | (+) white (-) blue |
| S | -50 to 1768°C -58 to 3214°F | 4.5 | 15.0 | no standard | (+) white (-) blue |
| B | 200 to 1820°C 392 to 3308°F | 9.1<540°C 4.5>540°C | 42.6<540°C 15.0>540°C | no standard | no standard |
| N | -200 to 1300°C -328 to 2372°F | 2.8 | 8.1 | (+) orange (-) red | (+) orange (-) blue |
| C (W5/W26) | 0 to 2315°C 32 to 4199°F | 1.9 | 6.1 | no standard | no standard |
| mV | -10.00 to 65.00 | 0.02 mV | 0.08 mV | no standard | no standard |

*After 20 min. warm-up. Accuracy is specified in two ways: Accuracy at 23°C and 15 to 75% RH environment; and Accuracy over a 0 to 50 °C and 0 to 85% RH (non condensing) environment. Accuracy specified over the 0 to 50 °C operating range includes meter tempco and cold junction tracking effects.

The specification includes the A/D conversion errors, linearization conformity, and thermocouple cold junction compensation. Total system accuracy is the sum of meter and probe errors. Accuracy may be improved by field calibrating the meter readout at the temperature of interest.

5. **RTD INPUTS:**

Type: 2, 3 or 4 wire

Excitation Current:

100 ohm range: 165 µA; 10 ohm range: 2.5 mA

Lead Resistance:

100 ohm range: 10 Ω/lead max.; 10 ohm range: 3 Ω/lead max.

Balanced Lead Resistance: Automatically compensated up to max per lead

Unbalanced Lead Resistance: Uncompensated

Max. Continuous Overvoltage: 30 VDC

Failed Sensor Indication: *DPE#* or *Shark*

| RTD TYPE | RANGE | ACCURACY* @ 23°C | ACCURACY* @ 0 to 50°C | STANDARD |
|----------------------------------|---------------|------------------|-----------------------|----------------------|
| 100 ohm Pt alpha = .00385 | -200 to 850°C | 0.4°C | 1.6°C | IEC 751 |
| 100 ohm Pt alpha = .00392 | -200 to 850°C | 0.4°C | 1.6°C | no official standard |
| 120 ohm Nickel alpha = .00672 | -80 to 260°C | 0.2°C | 0.5°C | no official standard |
| 10 ohm Copper alpha = .00427 | -100 to 260°C | 0.4°C | 0.9°C | no official standard |

*After 20 min. warm-up. Accuracy is specified in two ways: Accuracy at 23°C and 15 to 75% RH environment; and Accuracy over a 0 to 50°C and 0 to 85% RH (non condensing) environment. Accuracy specified over the 0 to 50°C operating range includes meter tempco effects.

The specification includes the A/D conversion errors and linearization conformity. Total system accuracy is the sum of meter and probe errors. Accuracy may be improved by field calibrating the meter readout at the temperature of interest.

6. **USER INPUT:** Programmable input

Software selectable for active logic state: active low, pull-up (24.7 KΩ to +5 VDC) or active high, pull-down resistor (20 KΩ).

Trigger levels: V_{IL} = 1.0 V max; V_{IH} = 2.4 V min; V_{MAX} = 28 VDC

Response Time: 10 msec typ.; 50 msec debounce (activation and release)

7. **MEMORY:** Nonvolatile E²PROM retains all programming parameters and max/min values when power is removed.

8. **OUTPUTS:**

Type: Dual Form C contacts

Isolation to Sensor & User Input Commons: 1400 Vrms for 1 min.

Working Voltage: 150 Vrms

Contact Rating: 5 amps @ 120/240 VAC or 28 VDC (resistive load), 1/8 H.P. @ 120 VAC (inductive load)

Life Expectancy: 100 K cycles min. at full load rating. External RC snubber extends relay life for operation with inductive loads.

Response Time: Turn On or Off: 4 msec max.

9. **ENVIRONMENTAL CONDITIONS:**

Operating temperature: 0 to 50 °C

Storage temperature: -40 to 70 °C

Operating and storage humidity: 0 to 85% max. RH (non-condensing)

Vibration According to IEC 68-2-6: Operational 5 to 150 Hz, in X, Y, Z direction for 1.5 hours, 2 g's.

Shock According to IEC 68-2-27: Operational 30 g's (10 g's relay), 11 msec in 3 directions.

Altitude: Up to 2,000 meters

10. **CONNECTIONS:** High compression cage-clamp terminal block

Wire Strip Length: 0.3" (7.5 mm)

Wire Gage: 30-14 AWG copper wire

Torque: 4.5 inch-lbs (0.51 N-m) max.

11. **CONSTRUCTION:** This unit is rated for NEMA 4X/IP65 outdoor use. IP20

Touch safe. Installation Category II, Pollution Degree 2. One piece bezel/case. Flame resistant. Synthetic rubber keypad. Panel gasket and mounting clip included.

12. **CERTIFICATIONS AND COMPLIANCES:**

SAFETY

Type 4X Enclosure rating (Face only), UL50

IEC 61010-1, EN 61010-1: Safety requirements for electrical equipment for measurement, control, and laboratory use, Part 1.

IP65 Enclosure rating (Face only), IEC 529

IP20 Enclosure rating (Rear of unit), IEC 529

For Model No. PAXLT0U0 Only: UL Listed, File # E137808, UL508, CSA C22.2 No. 14-M95

Listed by Und. Lab. Inc. to U.S. and Canadian safety standards

ELECTROMAGNETIC COMPATIBILITY

Emissions and Immunity to EN 61326: Electrical Equipment for Measurement, Control and Laboratory use.

Immunity to Industrial Locations:

| | | |
|---------------------------|--------------|---|
| Electrostatic discharge | EN 61000-4-2 | Criterion A 4 kV contact discharge 8 kV air discharge |
| Electromagnetic RF fields | EN 61000-4-3 | Criterion B 10 V/m |
| Fast transients (burst) | EN 61000-4-4 | Criterion B 2 kV power 1 kV signal |
| Surge | EN 61000-4-5 | Criterion A 1 kV L-L, 2 kV L&N-E power |
| RF conducted interference | EN 61000-4-6 | Criterion B 3 V/rms |

Emissions:

| | | |
|-----------|----------|---------|
| Emissions | EN 55011 | Class A |
|-----------|----------|---------|

Notes:

1. *Criterion A: Normal operation within specified limits.*

2. *Criterion B: Temporary loss of performance from which the unit self-recovers.*

13. **WEIGHT:** 10.4 oz. (295 g)

1.0 INSTALLING THE METER

Installation

The PAX Lite meets NEMA 4X/IP65 requirements when properly installed. The unit is intended to be mounted into an enclosed panel. Prepare the panel cutout to the dimensions shown. Remove the panel latch from the unit. Slide the panel gasket over the rear of the unit to the back of the bezel. The unit should be installed fully assembled. Insert the unit into the panel cutout.

While holding the unit in place, push the panel latch over the rear of the unit so that the tabs of the panel latch engage in the slots on the case. The panel latch should be engaged in the farthest forward slot possible. To achieve a proper seal, tighten the latch screws evenly until the unit is snug

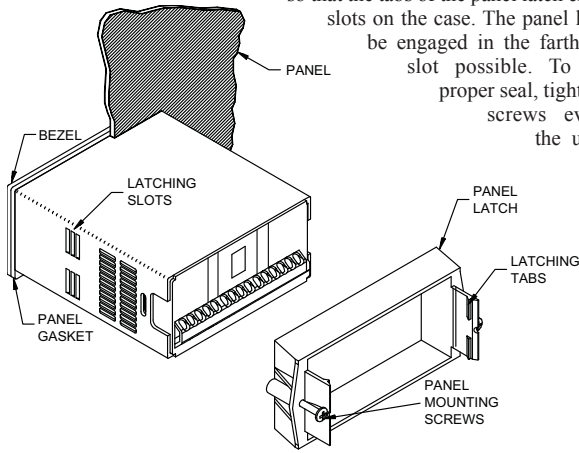

in the panel (Torque to approximately 7 in-lbs [79N-cm]). Do not over-tighten the screws.

Installation Environment

The unit should be installed in a location that does not exceed the maximum operating temperature and provides good air circulation. Placing the unit near devices that generate excessive heat should be avoided.

The bezel should be cleaned only with a soft cloth and neutral soap product. Do NOT use solvents. Continuous exposure to direct sunlight may accelerate the aging process of the bezel.

Do not use tools of any kind (screwdrivers, pens, pencils, etc.) to operate the keypad of the unit.

PANEL CUT-OUT

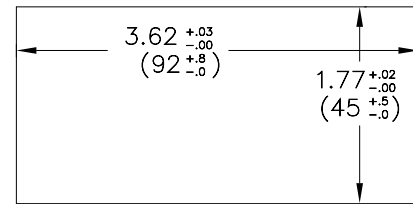

2.0 SETTING THE JUMPER

INPUT RANGE JUMPER (RTD ONLY)

This jumper is used to select the proper input range for the RTD probe being used (10 ohm or 100 ohm). For thermocouple inputs, this jumper has no effect and can be left in either position.

To access the jumper, remove the meter base from the case by firmly squeezing and pulling back on the side rear finger tabs. This should lower the latch below the case slot (which is located just in front of the finger tabs). It is recommended to release the latch on one side, then start on the other side latch.

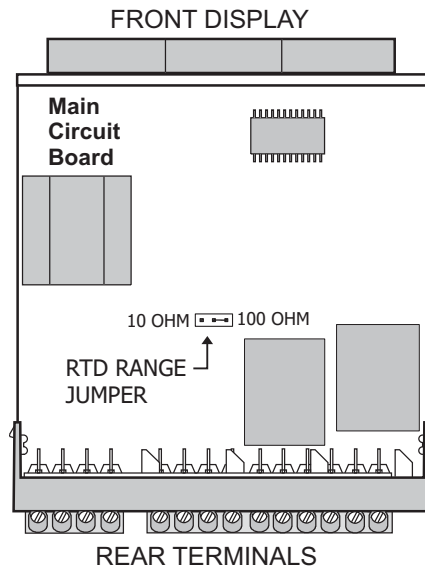

3.0 WIRING THE METER

WIRING OVERVIEW

Electrical connections are made via screw-clamp terminals located on the back of the meter. All conductors should conform to the meter's voltage and current ratings. All cabling should conform to appropriate standards of good installation, local codes and regulations. It is recommended that the power supplied to the meter (DC or AC) be protected by a fuse or circuit breaker.

When wiring the meter, compare the numbers embossed on the back of the meter case against those shown in wiring drawings for proper wire position. Strip the wire, leaving approximately 0.3" (7.5 mm) bare lead exposed (stranded wires should be tinned with solder.) Insert the lead under the correct screw-clamp terminal and tighten until the wire is secure. (Pull wire to verify tightness.)

EMC INSTALLATION GUIDELINES

Although this meter is designed with a high degree of immunity to Electro-Magnetic Interference (EMI), proper installation and wiring methods must be followed to ensure compatibility in each application. The type of the electrical noise, source or coupling method into the meter may be different for various installations. The meter becomes more immune to EMI with fewer I/O connections. Cable length, routing, and shield termination are very important and can mean the difference between a successful or troublesome installation. Listed below are some EMC guidelines for successful installation in an industrial environment.

1. The meter should be properly connected to protective earth.
2. Use shielded (screened) cables for all Signal and Control inputs. The shield (screen) pigtail connection should be made as short as possible. The connection point for the shield depends somewhat upon the application.

Listed below are the recommended methods of connecting the shield, in order of their effectiveness.

- a. Connect the shield only at the panel where the unit is mounted to earth ground (protective earth).
 - b. Connect the shield to earth ground at both ends of the cable, usually when the noise source frequency is above 1 MHz.
 - c. Connect the shield to common of the meter and leave the other end of the shield unconnected and insulated from earth ground.
3. Never run Signal or Control cables in the same conduit or raceway with AC power lines, conductors feeding motors, solenoids, SCR controls, and heaters, etc. The cables should be ran in metal conduit that is properly grounded. This is especially useful in applications where cable runs are long and portable two-way radios are used in close proximity or if the installation is near a commercial radio transmitter.
 4. Signal or Control cables within an enclosure should be routed as far as possible from contactors, control relays, transformers, and other noisy components.
 5. In extremely high EMI environments, the use of external EMI suppression devices, such as ferrite suppression cores, is effective. Install them on Signal and Control cables as close to the unit as possible. Loop the cable through the

core several times or use multiple cores on each cable for additional protection. Install line filters on the power input cable to the unit to suppress power line interference. Install them near the power entry point of the enclosure. The following EMI suppression devices (or equivalent) are recommended:

Ferrite Suppression Cores for signal and control cables:

Fair-Rite # 0443167251 (RLC# FCOR0000)

TDK # ZCAT3035-1330A

Steward # 28B2029-0A0

Line Filters for input power cables:

Schaffner # FN610-1/07 (RLC# LFIL0000)

Schaffner # FN670-1.8/07

Corcom # 1 VR3

Note: Reference manufacturer's instructions when installing a line filter.

6. Long cable runs are more susceptible to EMI pickup than short cable runs. Therefore, keep cable runs as short as possible.
7. Switching of inductive loads produces high EMI. Use of snubbers across inductive loads suppresses EMI.
Snubber: RLC# SNUB0000.

3.1 POWER WIRING

Power

Terminal 1: VAC/DC +

Terminal 2: VAC/DC -

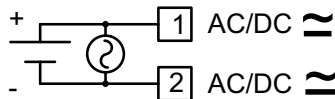

3.2 INPUT SIGNAL WIRING



CAUTION: Sensor input common (Terminal 7) is NOT isolated from user common (Terminal 9). In order to preserve the safety of the meter application, the sensor input common must be suitably isolated from hazardous live earth referenced voltages; or input common and user common must be at protective earth ground potential. If not, hazardous live voltage may be present at the user input and user common terminals. Appropriate considerations must then be given to the potential of the sensor input common and the user common with respect to earth ground.

THERMOCOUPLE

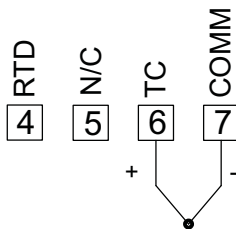

2-WIRE RTD

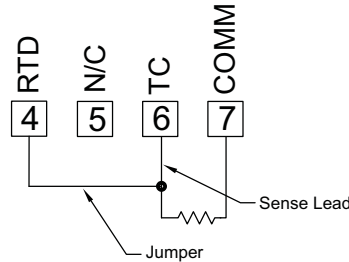

3-WIRE RTD

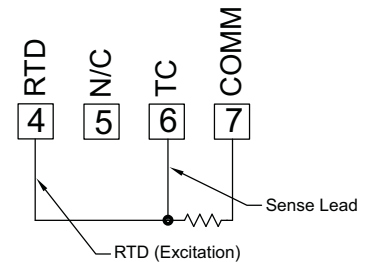

3.3 USER INPUT WIRING

Terminal 8: User Input

Terminal 9: User Common

Current Sinking (Active Low Logic)

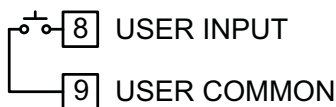

Current Sourcing (Active High Logic)

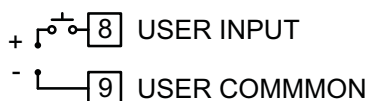

3.4 SETPOINT (OUTPUT) WIRING

Terminal 10: NC 1

Terminal 11: NO 1

Terminal 12: Relay 1 Common

Terminal 13: NC 2

Terminal 14: NO 2

Terminal 15: Relay 2 Common

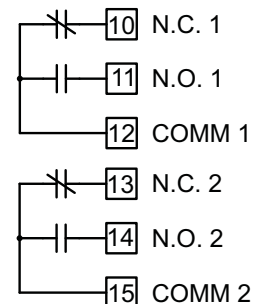

4.0 REVIEWING THE FRONT BUTTONS AND DISPLAY

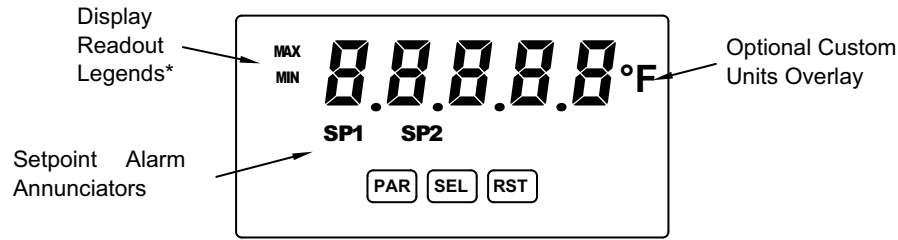

| BUTTON | DISPLAY MODE OPERATION |
|--------|--------------------------------------|
| PAR | Access Programming Mode |
| SEL | Index display through enabled values |
| RST | Resets values (min/max) or outputs |

| PROGRAMMING MODE OPERATION |
|---|
| Store selected parameter and index to next parameter |
| Advance through selection list/select digit position in parameter value |
| Increment selected digit of parameter value |

OPERATING MODE DISPLAY DESIGNATORS

MAX - Maximum display capture value
 MIN - Minimum display capture value

"SP1" - Indicates setpoint 1 output activated.
 "SP2" - Indicates setpoint 2 output activated.

Pressing the **SEL** button toggles the meter through the selected displays. If display scroll is enabled, the display will toggle automatically every four seconds between the enabled display values.

5.0 PROGRAMMING THE METER

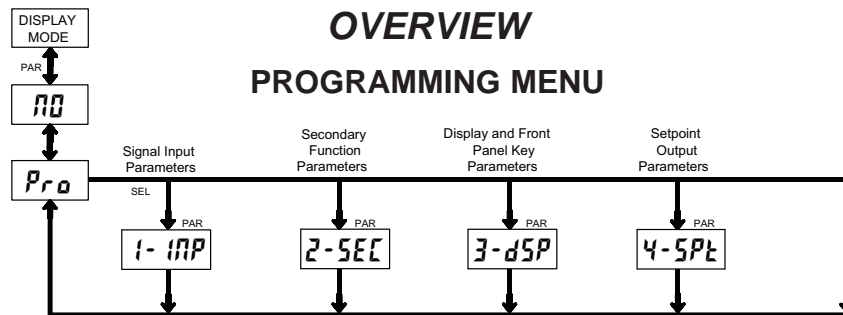

PROGRAMMING MODE ENTRY (PAR BUTTON)

It is recommended all programming changes be made off line, or before installation. The meter normally operates in the Display Mode. No parameters can be programmed in this mode. The Programming Mode is entered by pressing the **PAR** button. If it is not accessible, then it is locked by either a security code or a hardware lock.

MODULE ENTRY (SEL & PAR BUTTONS)

The Programming Menu is organized into four modules. These modules group together parameters that are related in function. The display will alternate between **Pr0** and the present module. The **SEL** button is used to select the desired module. The displayed module is entered by pressing the **PAR** button.

MODULE MENU (PAR BUTTON)

Each module has a separate module menu (which is shown at the start of each module discussion). The **PAR** button is pressed to advance to a particular parameter to be changed, without changing the programming of preceding parameters. After completing a module, the display will return to **Pr0**. Programming may continue by accessing additional modules.

SELECTION / VALUE ENTRY

For each parameter, the display alternates between the present parameter and the selections/value for that parameter. The **SEL** and **RST** buttons are used to move through the selections/values for that parameter. Pressing the **PAR** button, stores and activates the displayed selection/value. This also advances the meter to the next parameter.

For numeric values, the value is displayed with one digit flashing (initially the right most digit). Pressing the **RST** button increments the digit by one or the user can hold the **RST** button and the digit will automatically scroll. The **SEL** button will select the next digit to the left. Pressing the **PAR** button will enter the value and move to the next parameter.

PROGRAMMING MODE EXIT (PAR BUTTON)

The Programming Mode is exited by pressing the **PAR** button with **Pr0** displayed. This will commit any stored parameter changes to memory and return the meter to the Display Mode. (If power loss occurs before returning to the Display Mode, verify recent parameter changes.)

PROGRAMMING TIPS

It is recommended to start with Module 1 and proceed through each module in sequence. When programming is complete, it is recommended to record the parameter programming and lock out parameter programming with the user input or programming security code.

FACTORY SETTINGS

Factory Settings may be completely restored in Module 2. This is useful when encountering programming problems.

ALTERNATING SELECTION DISPLAY

In the explanation of the modules, the following dual display with arrows will appear. This is used to illustrate the display alternating between the parameter on top and the parameter's Factory Setting on the bottom. In most cases, selections and values for the parameter will be listed on the right.

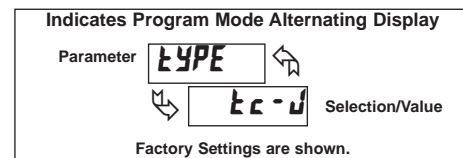

5.1 MODULE 1 - INPUT SETUP PARAMETERS (1- INP)

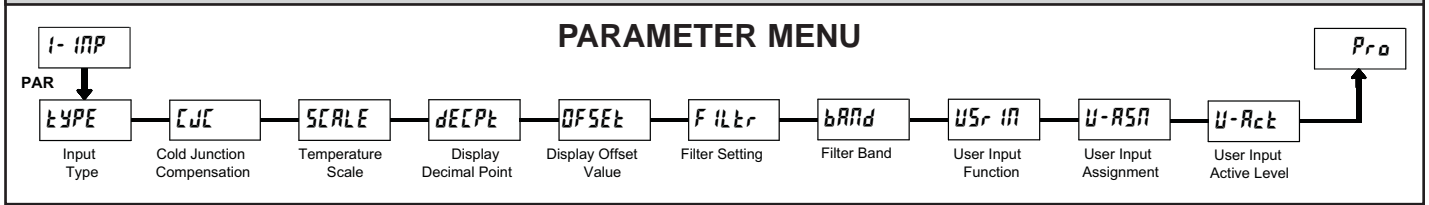

INPUT TYPE

| SELECTION | INPUT TYPE | SELECTION | INPUT TYPE |
|-----------|------------|-----------|--------------------|
| tc-t | T | tc-n | N |
| tc-E | E | tc-C | C |
| tc-J | J | u0Lk | mV |
| tc-K | K | Pt385 | Platinum 385 100 Ω |
| tc-R | R | Pt392 | Platinum 392 100 Ω |
| tc-S | S | Ni672 | Nickel 672 100 Ω |
| tc-b | B | Cu427 | Copper 427 10 Ω |

Select the thermocouple or RTD type used for the application. For RTDs, position the Input Range Jumper to match the RTD type (10Ω or 100Ω).

Selecting **u0Lk** displays a millivolt signal readout with 10 μV resolution.

COLD JUNCTION COMPENSATION



This parameter enables or disables internal cold junction compensation for thermocouples. For most applications, cold junction compensation should be enabled (**ON**). This parameter only appears for thermocouple input selections.

TEMPERATURE SCALE

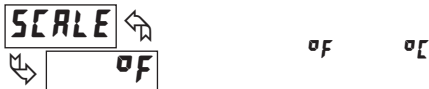

Select the desired temperature scale. This selection applies for the Input, MAX and MIN displays. This parameter does not appear when mV or RTD resistance display is enabled.

DISPLAY DECIMAL POINT



Set the decimal point for the desired display resolution. This selection applies for the Input, MAX and MIN displays, and also affects the Setpoint and Display Offset values. For mV or RTD resistance displays, the decimal point location is fixed and this parameter does not appear.

DISPLAY OFFSET VALUE

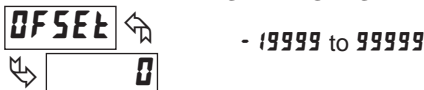

The temperature display can be corrected with an offset value. This can be used to compensate for probe errors, errors due to variances in probe placement or adjusting the readout to a reference thermometer.

FILTER SETTING



If the displayed temperature is difficult to read due to small process variations or noise, increased levels of filtering will help to stabilize the display.

Software filtering effectively combines a fraction of the current input reading with a fraction of the previous displayed reading to generate the new display.

Filter values represent no filtering (0), up to heavy filtering (3). A value of 1 for the filter uses 1/4 of the new input and 3/4 of the previous display to generate the new display. A filter value of 2 uses 1/8 new and 7/8 previous. A filter value of 3 uses 1/16 new and 15/16 previous.

FILTER BAND



0 to 199 display units

The filter will adapt to variations in the input signal. When the variation exceeds the input filter band value, the filter disengages. When the variation becomes less than the band value, the filter engages again. This allows for a stable readout, but permits the display to settle rapidly after a large process change. The value of the band is in display units, independent of the Display Decimal Point position. A band setting of '0' keeps the filter permanently engaged at the filter level selected above.

USER INPUT FUNCTION

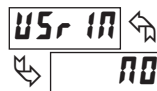

DISPLAY MODE
NO No Function

DESCRIPTION
User Input disabled.

P-Loc Program Mode Lock-out

See Programming Mode Access chart (Module 3).

rESEt Reset *

Reset the assigned value(s) to the current input value.

d-HLd Display Hold

Holds the assigned display, but all other meter functions continue as long as activated (maintained action).

d-SEL Display Select *

Advance once for each activation.

d-LEU Display Intensity Level *

Increase intensity one level for each activation.

rSE-1 Setpoint 1 Reset *

Reset setpoint 1 output.

rSE-2 Setpoint 2 Reset *

Reset setpoint 2 output.

rSE-12 Setpoint 1 and 2 Reset *

Reset both setpoint 1 and 2 outputs.

* Indicates Edge Triggered function. All others are Level Active functions.

USER INPUT ASSIGNMENT



HI HI-LO

LO dSP

Select the value(s) to which the User Input Function is assigned. The User Input Assignment only applies if a selection of reset or display hold is selected in the User Input Function menu.

USER INPUT ACTIVE LEVEL



HI LO

Select whether the user input is configured as active low or active high.

5.2 MODULE 2 - SECONDARY FUNCTION PARAMETERS (2-5EE)

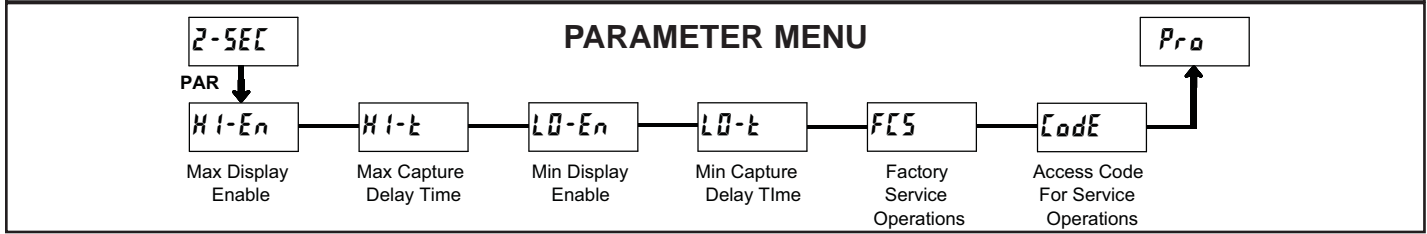

MAX DISPLAY ENABLE

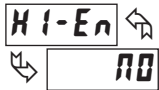

NO YES

Enables the Maximum Display Capture capability.

MAX CAPTURE DELAY TIME

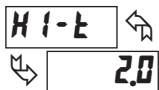

0.0 to 999.9 sec.

When the Input Display is above the present MAX value for the entered delay time, the meter will capture that display value as the new MAX reading. A delay time helps to avoid false captures of sudden short spikes.

MIN DISPLAY ENABLE

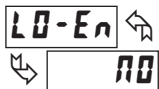

NO YES

Enables the Minimum Display Capture capability.

MIN CAPTURE DELAY TIME

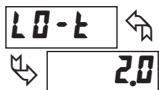

0.0 to 999.9 sec.

When the Input Display is below the present MIN value for the entered delay time, the meter will capture that display value as the new MIN reading. A delay time helps to avoid false captures of sudden short spikes.

FACTORY SERVICE OPERATIONS

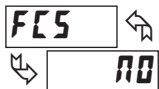

NO YES

Select YES to perform any of the Factory Service Operations shown below.

RESTORE FACTORY DEFAULT SETTINGS



Entering Code 66 will overwrite all user settings with the factory settings. The meter will display rESEt and then return to Code 00. Press the PAR button to exit the module

VIEW MODEL AND VERSION DISPLAY

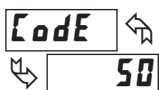

Entering Code 50 will display the version (x.x) of the meter. The display then returns to Code 00. Press the PAR button to exit the module.

TOGGLE RTD INPUT DISPLAY MODE

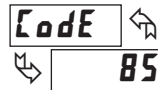

Entering Code 85 toggles the selected RTD input display mode between a temperature or resistance readout. The resistance readout is useful for diagnostic purposes before and after calibration, or to display the measured resistance of a connected RTD probe.

For RTD type Lu427 (Input Range Jumper in 10Ω position), resistance is displayed in 0.000 ohms resolution. For all other RTD types (100Ω position), resistance is displayed in 0.00 ohms resolution.

Upon entering Code 85, the meter displays either dSP-t or dSP-r to indicate temperature or resistance readout selected. The display then returns to Code 00. Press the PAR button to exit the module.

CALIBRATION



The PAXLT uses stored calibration values to provide accurate temperature measurements. Over time, the electrical characteristics of the components inside the meter could slowly change, with the result being that the stored calibration values may no longer accurately define the input circuit. For most applications, recalibration every 1 to 2 years should be sufficient.

Calibration for thermocouple inputs involves a voltage calibration and a cold junction calibration. It is recommended that both calibrations be performed. The voltage calibration must precede cold junction calibration.

Calibration of the meter should only be performed by persons experienced in calibrating electronic equipment. Allow a minimum 30 minute warm up before performing any calibration procedures. The following procedures should be performed at an ambient temperature of 15 to 35°C (59 to 95°F).

CAUTION: The accuracy of the calibration equipment will directly affect the accuracy of the meter.

10 OHM RTD Range Calibration

1. Set the Input Range Jumper to 10 ohm position.
2. With the display at Code 48, press the PAR key. Unit displays CAL NO.
3. Press SEL to select 10 ohm range. Display reads CAL r 10.
4. Press PAR. Display reads 00r.
5. Apply a direct short to terminals RTD (4), TC (6) and COMM (7) using a three wire link. Press PAR. Display reads CAL for about 10 seconds.
6. When the display reads 150r, apply a precision resistance of 15 ohms (with an accuracy of 0.01% or better) to terminals RTD, TC and COMM using a three wire link. Press PAR. Display reads CAL for about 10 seconds.
7. When display reads CAL NO, press PAR twice to exit calibration and return to the normal display mode.

100 OHM RTD Range Calibration

1. Set the Input Range Jumper to 100 ohm position.
2. With the display at Code 48, press the PAR key. Unit displays CAL NO.
3. Press SEL twice to select 100 ohm range. Display reads CAL r 100.
4. Press PAR. Display reads 00r.
5. Apply a direct short to terminals RTD (4), TC (6) and COMM (7) using a three wire link. Press PAR. Display reads CAL for about 10 seconds.
6. When the display reads 3000r, apply a precision resistance of 300 ohms (with an accuracy of 0.01% or better) to terminals RTD, TC and COMM using a three wire link. Press PAR. Display reads CAL for about 10 seconds.
7. When display reads CAL NO, press PAR twice to exit calibration and return to the normal display mode.

THERMOCOUPLE Voltage Calibration

1. Connect a precision DC voltage source with an accuracy of 0.01% or better to the TC and COMM terminals. Set the voltage source to zero.
2. With the display at **Code 48**, press the **PAR** key. Unit displays **CRJ RD**.
3. Press **SEL** until the display reads **CRJ LC** to select thermocouple input.
4. Press **PAR**. Display reads **00.0**.
5. With the voltage source set to zero, press **PAR**. Display reads **CRJ LC** for about 6 seconds.
6. When the display reads **6000.0**, set the voltage source output to 60.000 mV. Press **PAR**. Display reads **CRJ LC** for about 6 seconds.
7. When display reads **CRJ RD**, press **PAR** twice to exit calibration and return to the normal display mode. Proceed to Cold Junction Calibration.

THERMOCOUPLE Cold Junction Calibration

1. The ambient temperature must be between 20°C and 30°C.
2. Connect a thermocouple (types T, E, J, K or N only) with an accuracy of 1°C or better to the meter.
3. Enter programming mode and verify the following settings in Module 1:

TYPE = thermocouple type connected to the meter
CLC = 00; **SCALE** = °C; **DECPt** = 00; **OFFSEt** = 00

4. Place the thermocouple in close thermal contact to a reference thermometer probe. (Use a reference thermometer with an accuracy of 0.25°C or better.) The two probes should be shielded from air movement and allowed sufficient time to equalize in temperature. (A calibration bath of known temperature could be used in place of the thermometer.)
5. Compare the unit display with the reference temperature indicator (or calibration bath). If a difference of more than +/- 1.0°C exists, note the difference (CJ Error) and continue with cold junction calibration.
 CJ Error = Reference Temperature - Unit Display
6. Enter programming mode and proceed through Module 2 to the Service Access Code. Select **Code 48** and press **PAR**. Unit displays **CRJ RD**. Press **RST** to select **CLC**.
7. Press **PAR**. Display reads **CLC** followed by the current cold junction value. Calculate a new cold junction value as follows:
 New cold junction = Current cold junction + CJ Error (noted above)
8. Press **PAR** and set the display to the new cold junction value. Press **PAR** to enter the new value. Display reads **CRJ LC** for 6 seconds and returns to **CRJ RD**.
9. Press **PAR** twice to exit calibration and return to the normal display mode. Verify the input reading is correct. If not, repeat steps 5 through 9.

5.3 MODULE 3 - DISPLAY AND FRONT PANEL KEY PARAMETERS (3-dSP)

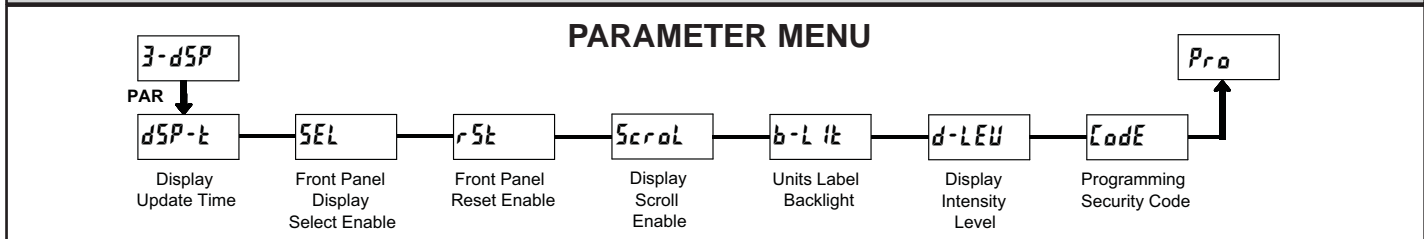

DISPLAY UPDATE TIME



This parameter sets the display update time in seconds.

DISPLAY INTENSITY LEVEL



Enter the desired Display Intensity Level (1-5). The display will actively dim or brighten as levels are changed.

FRONT PANEL DISPLAY SELECT ENABLE (SEL)



The **YES** selection allows the **SEL** key to toggle through the enabled displays.

FRONT PANEL RESET ENABLE (RST)



This selection allows the **RST** button to reset the selected value(s).

DISPLAY SCROLL ENABLE



The **YES** selection allows the display to automatically scroll through the enabled displays. The scroll rate is every 4 seconds. This parameter only appears when the MAX or MIN displays are enabled.

UNITS LABEL BACKLIGHT



The PAXLT includes two units overlay labels (°C and °F) which can be installed into the meter's bezel display assembly. The backlight for the units label is activated by this parameter.

PROGRAMMING SECURITY CODE



The Security Code determines the programming mode and the accessibility of programming parameters. This code can be used along with the Program Mode Lock-out (**P-Loc**) in the User Input Function parameter (Module 1).

Two programming modes are available. Full Programming mode allows all parameters to be viewed and modified. Quick Programming mode permits only user selected values to be modified, but allows direct access to these values without having to enter Full Programming mode.

Entering a Security Code from 1-99 enables Quick Programming mode, and displays a sublist to select which values appear in the Quick Programming menu. Values set to **YES** in the sublist are accessible in Quick Programming. These values include the Setpoints (**SP-1**, **SP-2**) and Display Intensity (**d-LEU**).

Programming any Security Code other than 0, requires this code to be entered at the **Code** prompt in order to access Full Programming mode. Quick Programming mode, if enabled, is accessed before the **Code** prompt appears.

| USER INPUT FUNCTION | USER INPUT STATE | SECURITY CODE | MODE WHEN "PAR" BUTTON IS PRESSED | FULL PROGRAMMING MODE ACCESS |
|---------------------|------------------|---------------|-----------------------------------|---|
| not P-Loc | --- | 0 | Full Programming | Immediate Access |
| | | 1-99 | Quick Programming | After Quick Programming with correct code entry at Code prompt * |
| | | 100-999 | Code prompt | With correct code entry at Code prompt * |
| P-Loc | Active | 0 | Programming Lock | No Access |
| | | 1-99 | Quick Programming | No Access |
| | | 100-999 | Code prompt | With correct code entry at Code prompt * |
| | Not Active | 0-999 | Full Programming | Immediate Access |

* Entering Code 222 allows access regardless of security code.

5.4 MODULE 4 - SETPOINT OUTPUT PARAMETERS (4-SPt)

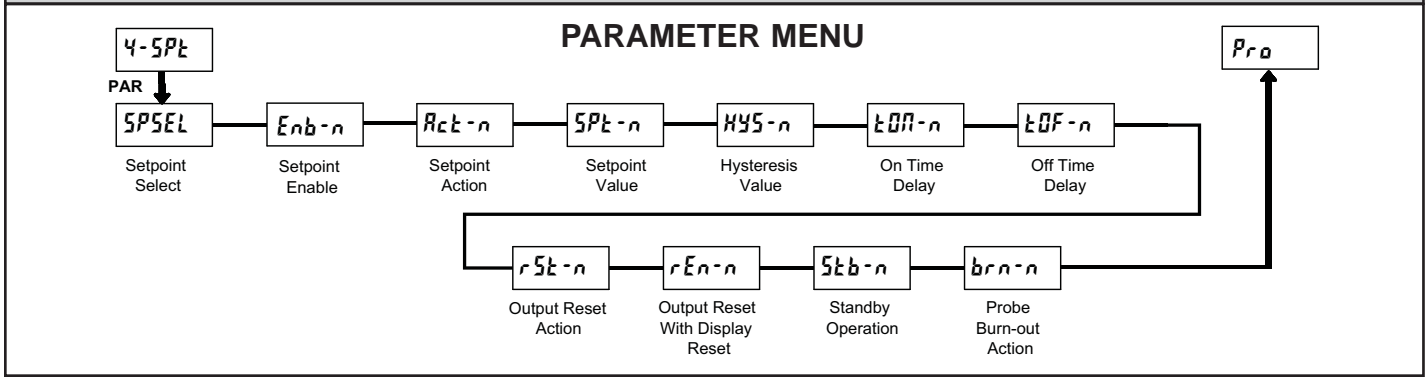

SETPOINT SELECT



Select the Setpoint Output to be programmed, starting with Setpoint 1. The “n” in the following parameters reflects the chosen Setpoint number. After the selected setpoint is completely programmed, the display returns to **SPSEL**. Repeat steps for Setpoint 2 if both Setpoints are being used. Select **NO** to exit the Setpoint programming module.

SETPOINT ENABLE

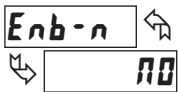

Select **YES** to enable Setpoint n and access the setup parameters. If **NO** is selected, the unit returns to **SPSEL** and Setpoint n is disabled.

SETPOINT ACTION



HI-bL LO-bL HI-Ub LO-Ub

Enter the action for the selected setpoint (output). See Setpoint Output Figures for a visual detail of each action.

- HI-bL = High Acting, with balanced hysteresis
- LO-bL = Low Acting, with balanced hysteresis
- HI-Ub = High Acting, with unbalanced hysteresis
- LO-Ub = Low Acting, with unbalanced hysteresis

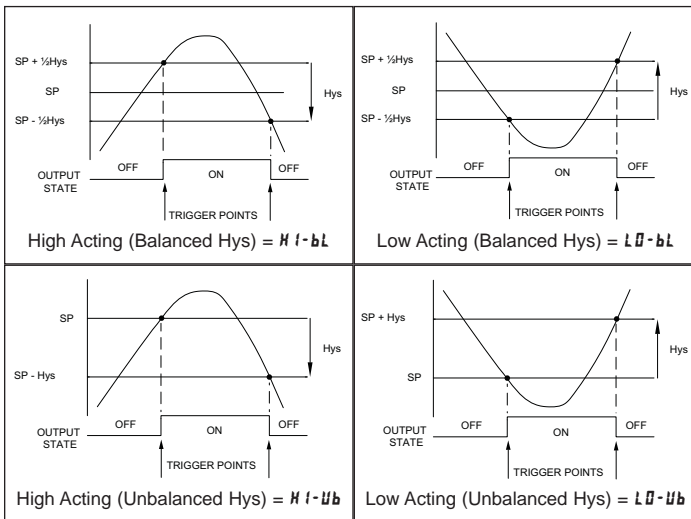

SETPOINT VALUE



- 19999 to 99999

Enter the desired setpoint value. The decimal point position for the setpoint and hysteresis values follow the selection set in Module 1.

HYSTERESIS VALUE



1 to 59999

Enter desired hysteresis value. See Setpoint Output Figures for visual explanation of how setpoint output actions (balanced and unbalanced) are affected by the hysteresis. When the setpoint is a control output, usually balanced hysteresis is used. For alarm applications, usually unbalanced hysteresis is used. For unbalanced hysteresis modes, the hysteresis functions on the low side for high acting setpoints and functions on the high side for low acting setpoints.

Note: Hysteresis eliminates output chatter at the switch point, while time delay can be used to prevent false triggering during process transient events.

ON TIME DELAY



0.0 to 5999 Sec

Enter the time value in seconds that the output is delayed from turning on after the trigger point is reached. A value of 0.0 allows the meter to update the output status per the response time listed in the Specifications.

OFF TIME DELAY

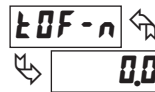

0.0 to 5999 Sec

Enter the time value in seconds that the output is delayed from turning off after the trigger point is reached. A value of 0.0 allows the meter to update the output status per the response time listed in the Specifications.

OUTPUT RESET ACTION

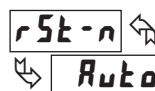

Auto LACKH L-dLY

Enter the reset action of the output. See figure for details.

Auto = Automatic action; This action allows the output to automatically reset off at the trigger points per the Setpoint Action shown in Setpoint Output Figures. The “on” output may be manually reset (off) immediately by the front panel **RST** button or user input. The output remains off until the trigger point is crossed again.

L-RstCH = Latch with immediate reset action; This action latches the output on at the trigger point per the Setpoint Action shown in Setpoint Output Figures. Latch means that the output can only be turned off by the front panel **RST** button or user input manual reset, or meter power cycle. When the user input or **RST** button is activated (momentary action), the corresponding "on" output is reset immediately and remains off until the trigger point is crossed again. (Previously latched alarms will be off if power up Display Value is lower than setpoint value.)

L-dLY = Latch with delay reset action; This action latches the output on at the trigger point per the Setpoint Action shown in Setpoint Output Figures. Latch means that the output can only be turned off by the front panel **RST** button or user input manual reset, or meter power cycle. When the user input or **RST** button is activated (momentary action), the meter delays the event until the corresponding "on" output crosses the trigger off point. (Previously latched outputs are off if power up Display Value is lower than setpoint value. During a power cycle, the meter erases a previous **L-dLY** reset if it is not activated at power up.)

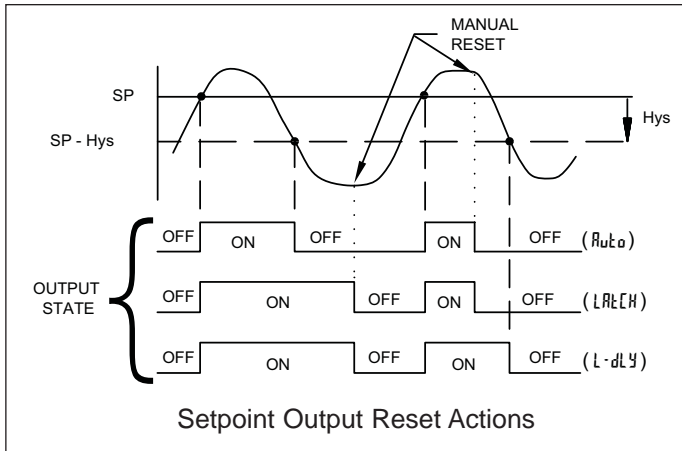

OUTPUT RESET WITH DISPLAY RESET



This parameter enables the **RST** button or user input to reset the output when the display is reset.

Note: For this parameter to operate, the **RST** button or User Input being used must be set to **dSP** and the Input value must be displayed. If these conditions are not met, the output will not reset.

STANDBY OPERATION



When **YES**, the output is disabled (after a power up) until the trigger point is crossed. Once the output is on, the output operates normally per the Setpoint Action and Output Reset Action.

PROBE BURN-OUT ACTION



Enter the probe burn-out action. In the event of a temperature probe failure (TC open; RTD open or short), the output can be programmed to be on or off.

PAXLT PROGRAMMING QUICK OVERVIEW

Press **PAR** key to enter Programming Mode.

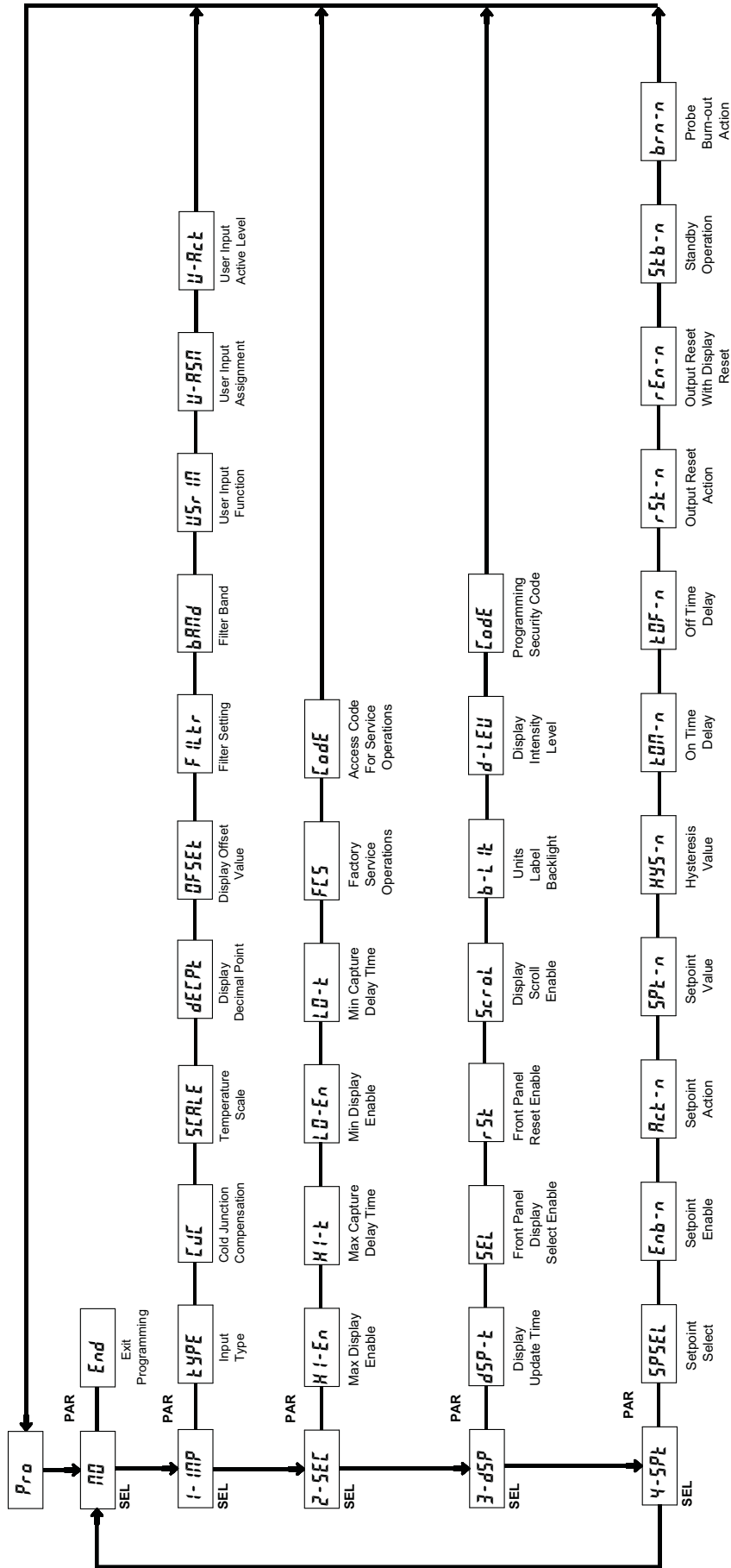

LIMITED WARRANTY

The Company warrants the products it manufactures against defects in materials and workmanship for a period limited to two years from the date of shipment, provided the products have been stored, handled, installed, and used under proper conditions. The Company's liability under this limited warranty shall extend only to the repair or replacement of a defective product, at The Company's option. The Company disclaims all liability for any affirmation, promise or representation with respect to the products.

The customer agrees to hold Red Lion Controls harmless from, defend, and indemnify RLC against damages, claims, and expenses arising out of subsequent sales of RLC products or products containing components manufactured by RLC and based upon personal injuries, deaths, property damage, lost profits, and other matters which Buyer, its employees, or sub-contractors are or may be to any extent liable, including without limitation penalties imposed by the Consumer Product Safety Act (P.L. 92-573) and liability imposed upon any person pursuant to the Magnuson-Moss Warranty Act (P.L. 93-637), as now in effect or as amended hereafter.

No warranties expressed or implied are created with respect to The Company's products except those expressly contained herein. The Customer acknowledges the disclaimers and limitations contained herein and relies on no other warranties or affirmations.

Red Lion Controls
Headquarters
20 Willow Springs Circle
York PA 17406
Tel +1 (717) 767-6511
Fax +1 (717) 764-0839

Red Lion Controls
Europe
Printerweg 10
NL - 3821 AD Amersfoort
Tel +31 (0) 334 723 225
Fax +31 (0) 334 893 793

Red Lion Controls
India
54, Vishvas Tenement
GST Road, New Ranip,
Ahmedabad-382480 Gujarat, India
Tel +91 987 954 0503
Fax +91 79 275 31 350

Red Lion Controls
China
Unit 101, XinAn Plaza
Building 13, No.99 Tianzhou Road
ShangHai, P.R. China 200223
Tel +86 21 6113-3688
Fax +86 21 6113-3683