

## SPECIFICATION

Part No. : **GW26.0152**

Product Name : 2.4GHz Miniature Screw mount Monopole Antenna

Feature : RP-SMA(M)  
Fixed 90°  
ROHS Compliant



## 1 Introduction

The GW.26 2.4 GHz Monopole RP-SMA(M) antenna is ideal for 2.4 GHz wireless applications such as Bluetooth and Wireless LAN. Connector mount is fully customizable.

## 2 Specification

| Wi-Fi 2.4GHz          |                       |
|-----------------------|-----------------------|
| Frequency             | 2400~2500MHz          |
| Bandwidth             | 1000MHz               |
| Peak Gain             | > 0dBi                |
| Radiation Efficiency  | > 40%                 |
| Radiation             | Omni-directional      |
| Polarization          | Vertical              |
| Power Handling 1W Max | Power Handling 1W Max |
| Electrical Wave       | Monopole              |
| Impedance             | 50Ω                   |
| Operating Temperature | -40°C ~ +85°C         |
| Storage Temperature   | -40°C ~ +85°C         |

## 3 Mechanical Properties

| Mechanical Properties |                 |
|-----------------------|-----------------|
| Colour                | Black and Green |
| Connector             | RP-SMA(M) R/A   |
| IP rating             | IP-65           |

# 4 Antenna Characteristics

## 4.1 Antenna S11

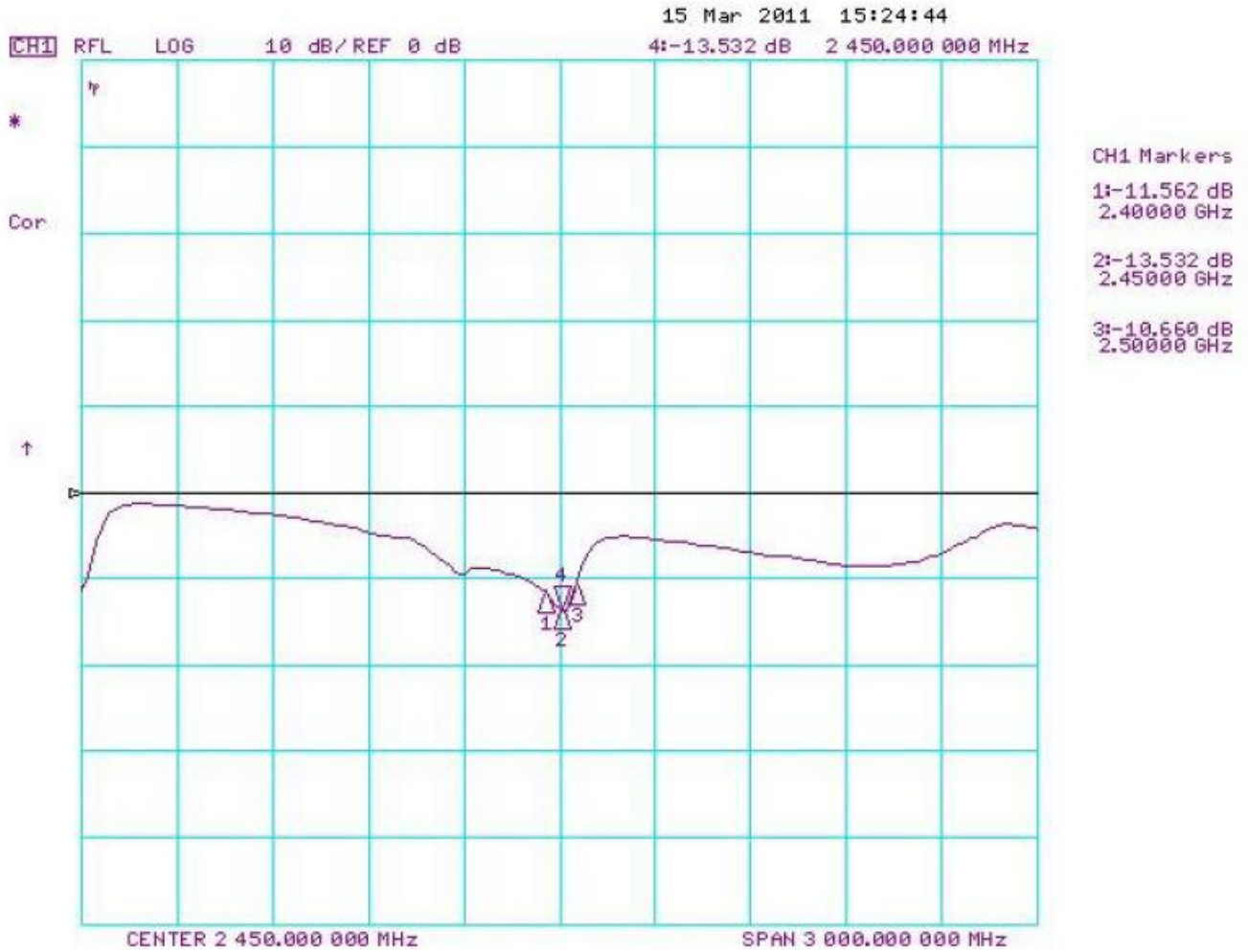

## 4.2 Antenna Peak Gain

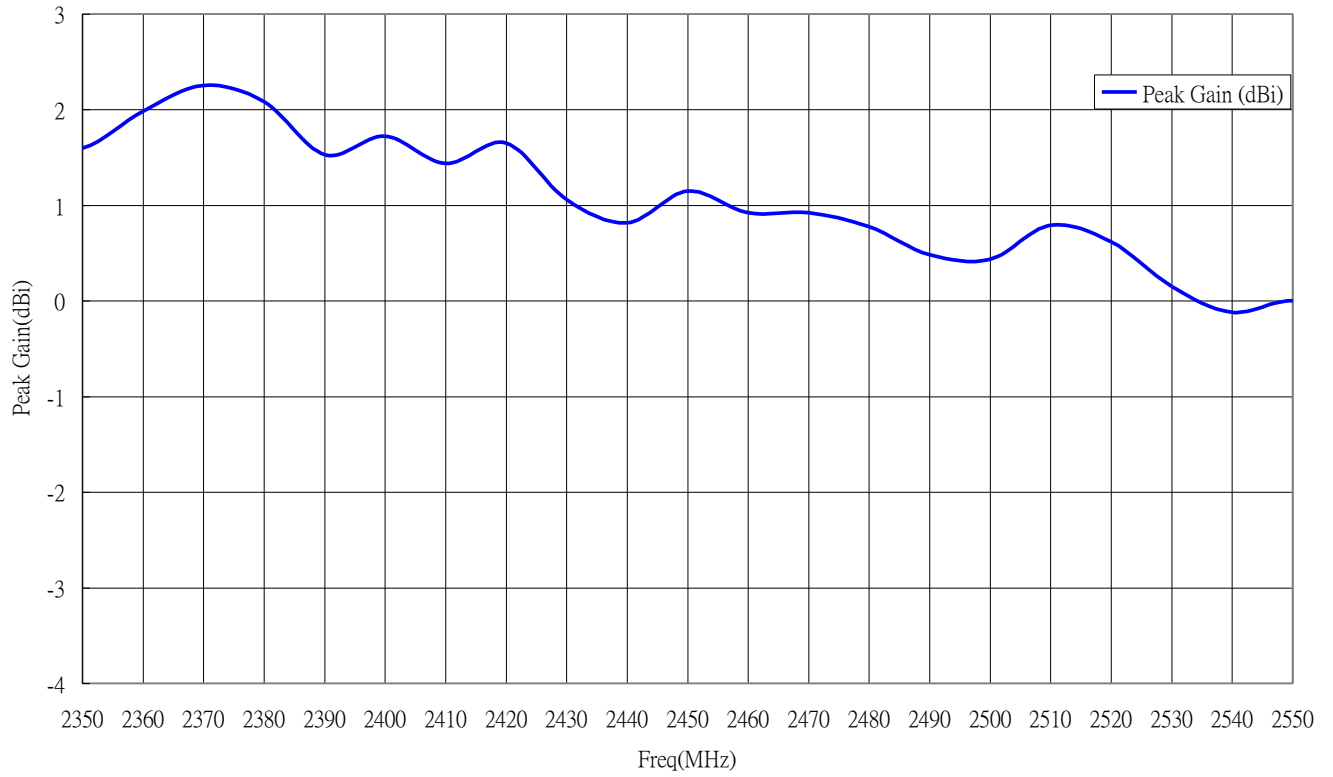

### 4.3 Antenna Efficiency

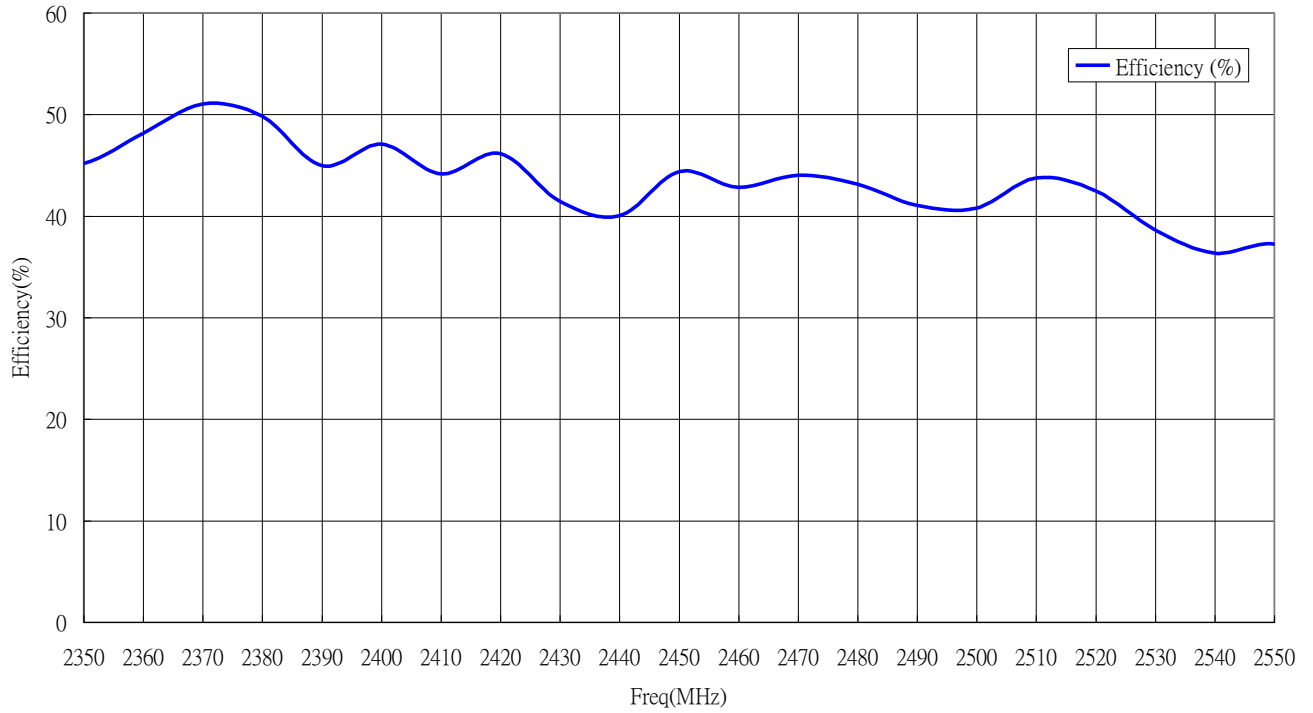

#### 4.4 Antenna pattern (XY plane)

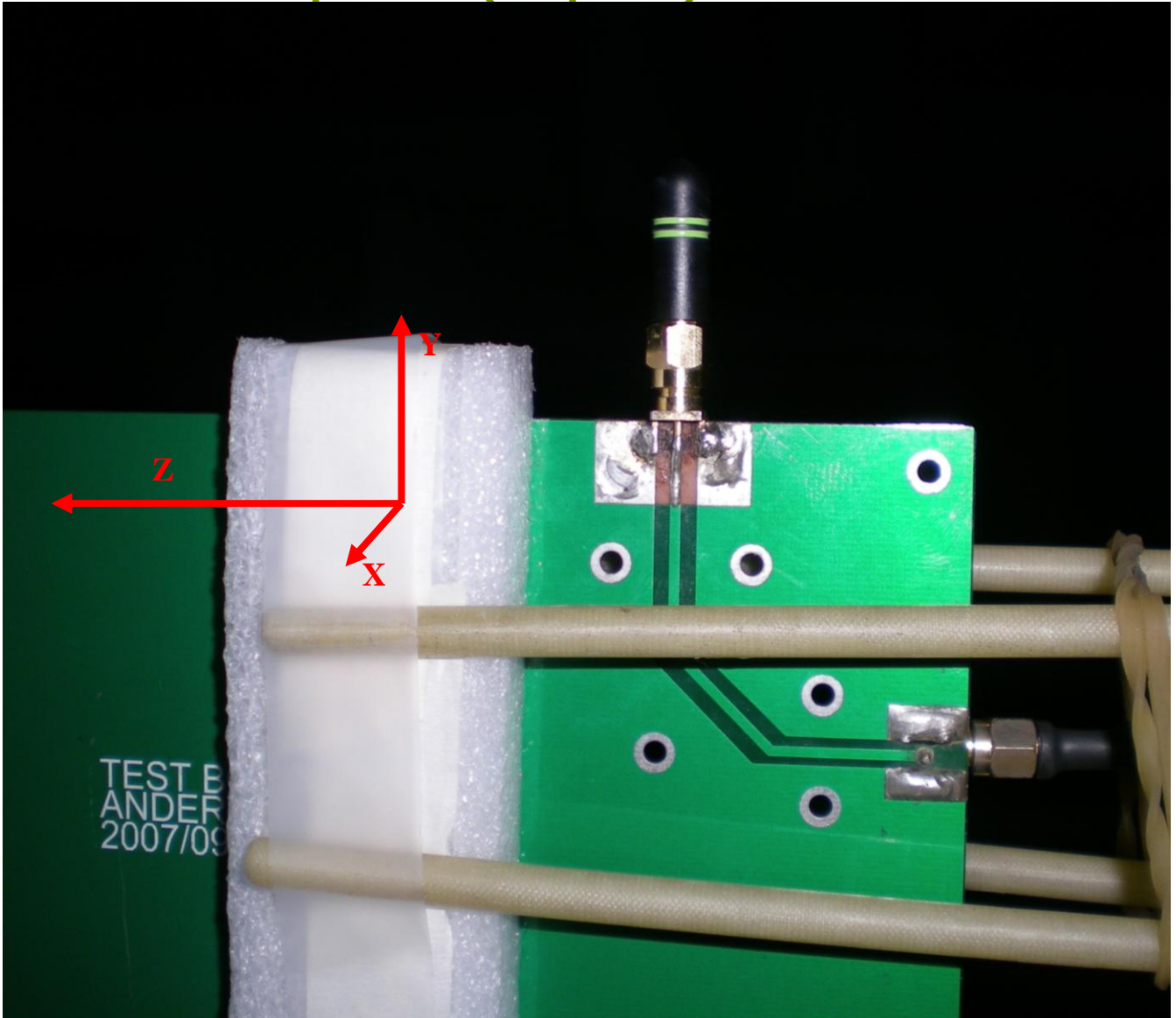

## 4.5 Antenna pattern (XY plane)

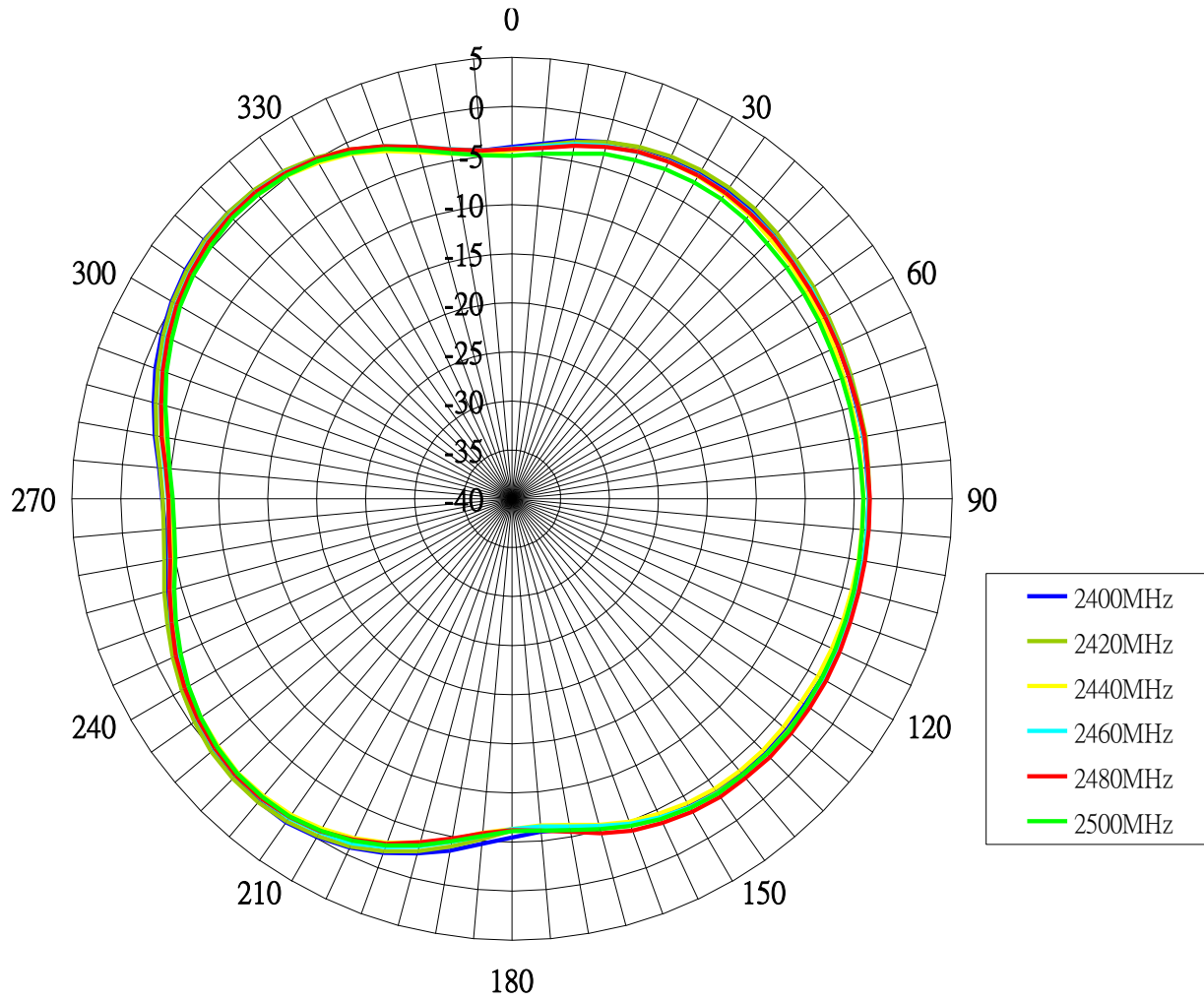

## 4.6 Antenna pattern (XZ plane)

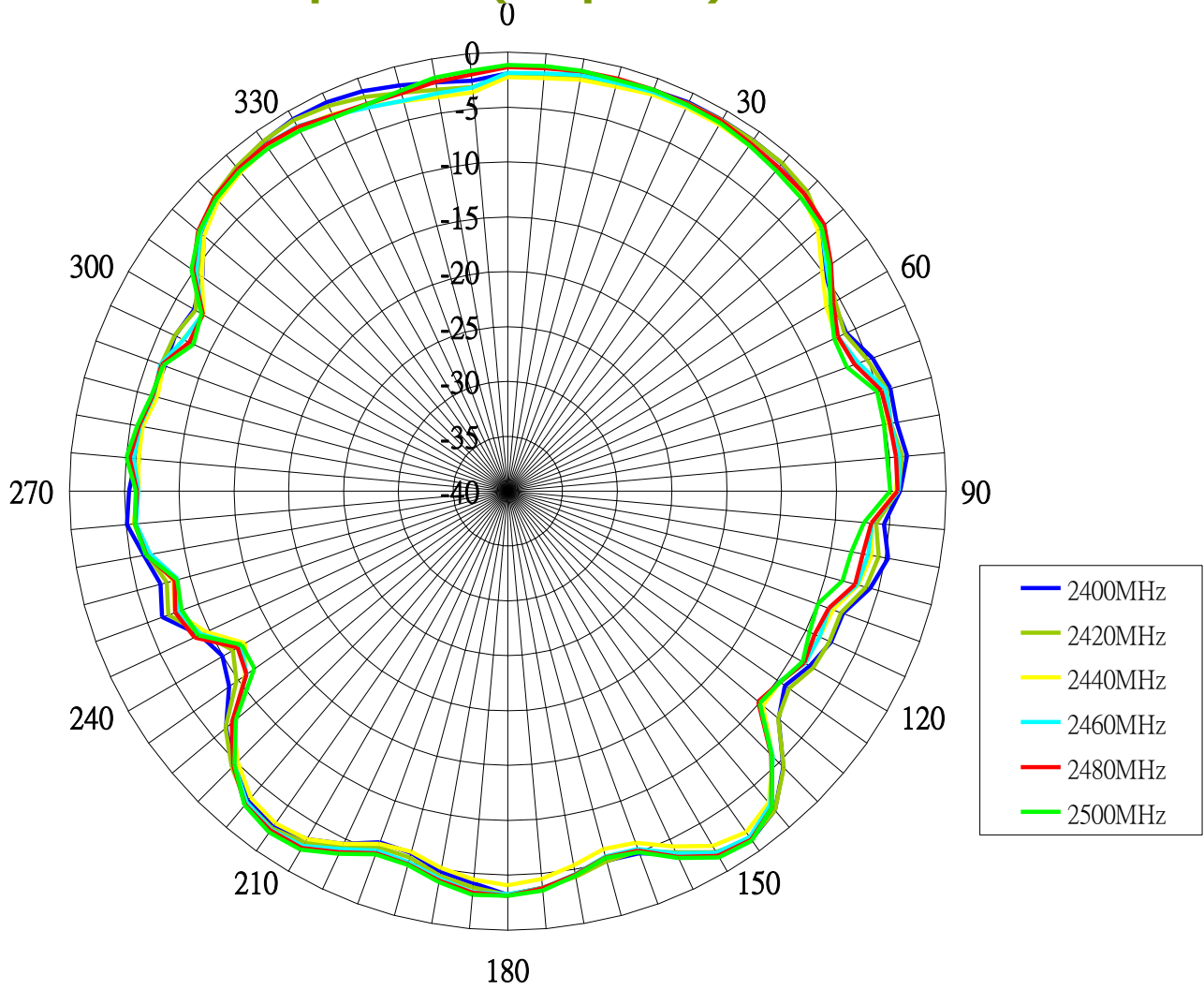



### 4.7 Antenna pattern (YZ plane)

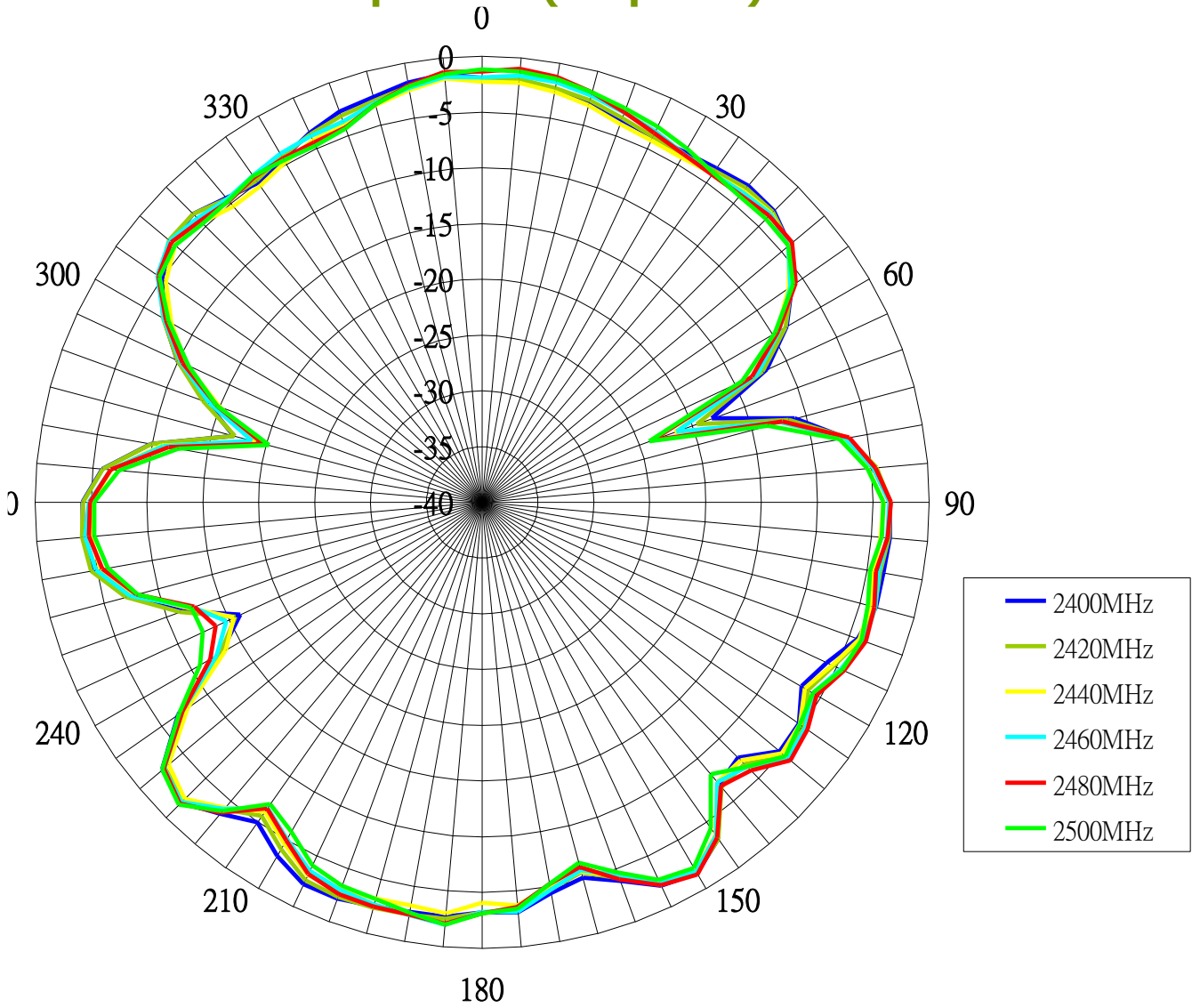

## 5. Outline Drawings and Structure

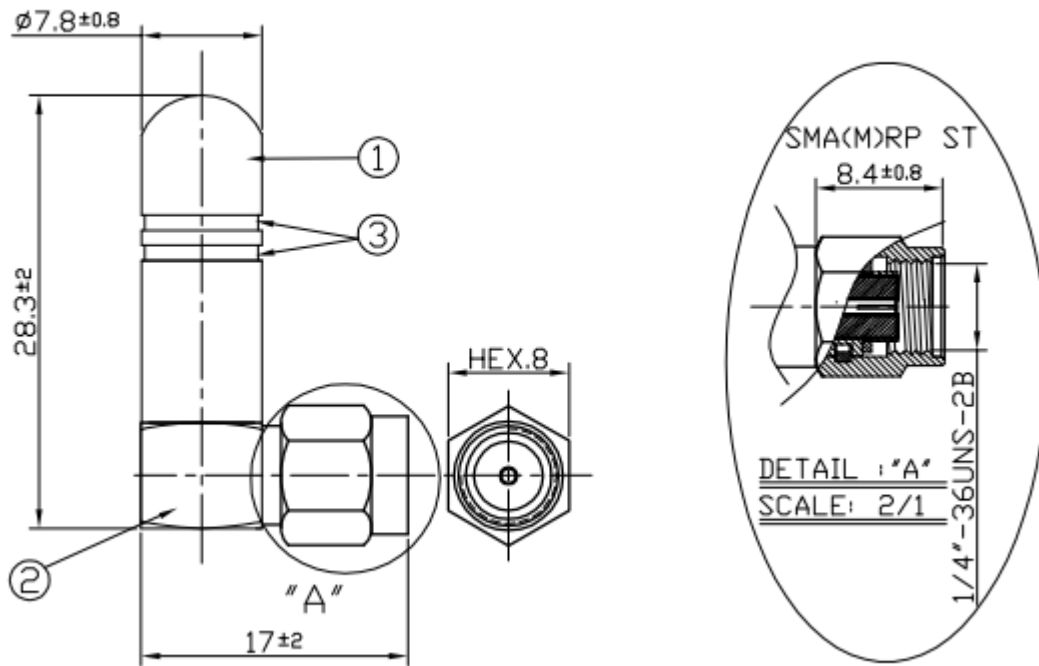

### Key

|   |                |             |
|---|----------------|-------------|
| 1 | Antenna Cover  | TPU(Black)  |
| 2 | Connector      | RP-SMA(M)   |
| 3 | Colour Stripes | Apple Green |