



Pantheon

MA760.A.ABIC.003

Specification

Part No.	MA760.A.ABIC.003
Product Name	Pantheon Antenna 4in1 MA.760 Screw-Mount (Permanent Mount) 2G/3G/4G MIMO LTE, GPS/GLONASS Wi-Fi 2.4/5GHz
Feature	<ul style="list-style-type: none"> • 2 x Cellular (2G/3G/4G) MIMO Antennas (698~960MHz, 1710~2170MHz,2300~2700MHz, 2900-3500MHz) · 2*MIMO • 1 x GPS/GLONASS 1575.42 ~ 1602MHz Active Antenna • 1 x Wi-Fi 2.4GHZ/ 5GHz Antennas IP67 Waterproof High Efficiency / Peak Gain Outdoor Antenna RoHS Compliant

1. Introduction

The MA760 4in1 antenna is an omni-directional heavy-duty, fully IP67 waterproof external M2M antenna for use in telematics, transportation and remote monitoring applications. It is the first antenna on the market to combine 4in1 that includes two LTE MIMO elements, one 2.4GHz/5GHz antenna and GPS/GLONASS in the highest efficiency and peak gain possible.

This unique antenna delivers powerful MIMO antenna technology for LTE while also fully compatible with legacy 2G and 3G networks worldwide, plus GPS/GLONASS for next generation high bandwidth telematics systems.

New fleet management and mobile and fixed video technology allows for real-time video uplink and downlink. High efficiency, high gain MIMO antennas

are necessary to achieve the high signal to noise ratio and throughput required to solve these challenges.

The Pantheon MA760 consists of two Cellular 2G/3G/4G MIMO elements working at 698-960MHz, 1710-2170MHz, 2300~2700MHz, 2900-3500MHz which means it can work worldwide, one high gain GPS/GLONASS antenna at 1575.42 MHz and one dual-band Wi-Fi 2.4GHz/5GHz antenna.

The 4 high efficiency and gain antennas are mounted in an extremely robust IP67 direct mount antenna package with excellent isolation (20dB+). The antenna has its own ground-plane and can radiate on any mounting environment like metal or plastic without affecting performance. The GPS/GLONASS antenna has a front end SAW filter configuration. The front-end

SAW increases protection against out of band LNA burn out.

The Dual-band Wi-Fi antenna has stable efficiency and peak gain on both bands even at 3 meters cable length where other antennas would have marked reduced performance.

The connectors and cable lengths are customizable.

The housing is also available in White. Recommended maximum cable length is 3 meters.

2. Specification

Cellular 2G/3G/4G MIMO

Frequency (MHz)	698~960	1710~2170	2300~2700	2900-3500
VSWR	3 Max			
Polarization	Vertical			
Impedance	50Ω			

2.4GHz / 5GHz ANTENNA

Frequency (GHz)	2.4 ~ 2.5	4.7 ~ 5.0	5.0 ~ 5.4	5.4 ~ 5.9
Peak Gain (dBi)	2.1	2.9	3.8	2.8
Average Gain (dBi)	-2.3	-3.6	-3.3	-3.8
Efficiency	60%	44%	46%	42%
VSWR	<=1.7:1			
Impedance	50Ω			
Polarization	Linear			
Radiation Pattern	Omni			

GPS-GLONASS

Centre Frequency	1575.42MHz / 1602MHz					
Bandwidth	10MHz					
Radiation Efficiency	50 (without cable)					
Passive Gain @ Zenith	4.0 typ (with $\psi=140$ mm ground)					
VSWR	2					
Impedance	50Ω					
DC Power Input Range	3 ~ 5V					
DC input	3.3V		4.0V		5.5V	
MHz	1575.42	1602	1575.42	1602	1575.42	1602
VSWR	2	2	2	2	2	2
LNA Gain	29.2	29	31	31	32.3	32
Noise Figure	3.1	3.1	3.2	3.2	3.4	3.4
Power Consumption	7.5	7.5	9.4	9.4	15	15
Band Attenuation	1520MHz: -20dB 1642MHz: -20dB		1520MHz: -20dB 1642MHz: -20dB		1520MHz: -20dB 1642MHz: -20dB	
Cable	3m RG-174 standard, fully customizable					
Connector	SMA(M) standard, fully customizable					

2. Specification

Mechanical

Antenna Dimensions	Height 85.7mm x Diameter 145.6mm
Casing	Wonderloy PC-540 PC/ABS Alloy
Waterproof	IP67
2G/3G/4G MIMO 1	3M Low Loss CFD-200 SMA(M)
2G/3G/4G MIMO 2	3M Low Loss CFD-200 SMA(M)
2.4/5GHz MIMO 1	3M Low Loss CFD-200 RP-SMA(M)
GPS/GLONASS	3M RG-174 SMA(M)

Environmental

Operation Temperature	-40°C to 85°C
Storage Temperature	-40°C to 90°C
Humidity	Non-condensing 65°C 95% RH

* All measurements were conducted with 3 meters low loss CFD200 cable

3. LTE MIMO

3.1 LTE MIMO 1 and LTE MIMO 2 Specification

3.1.1 Return Loss

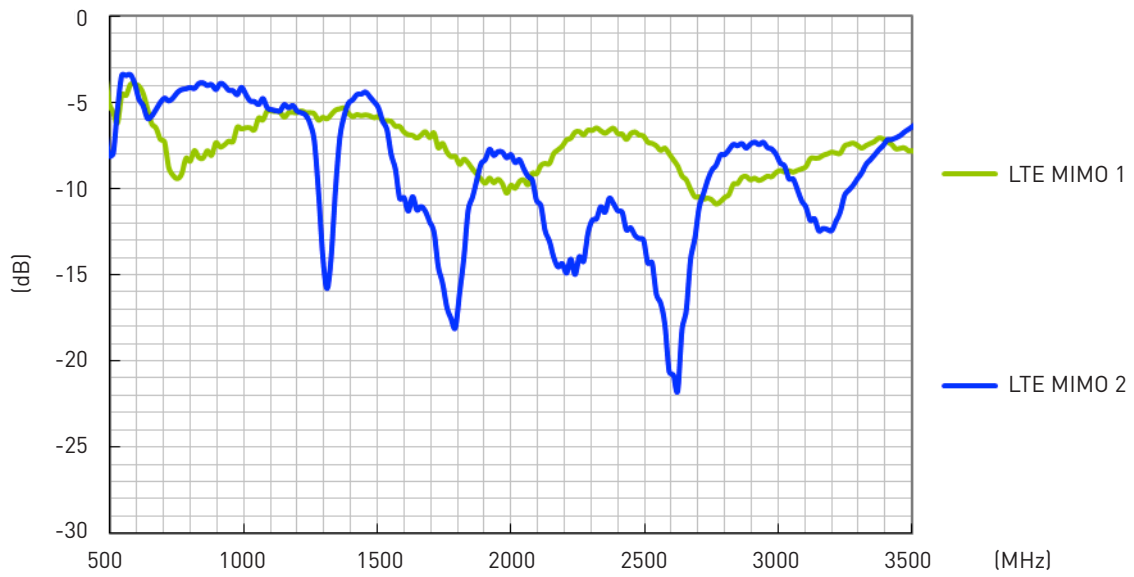

3.1.2 Maximum Gain

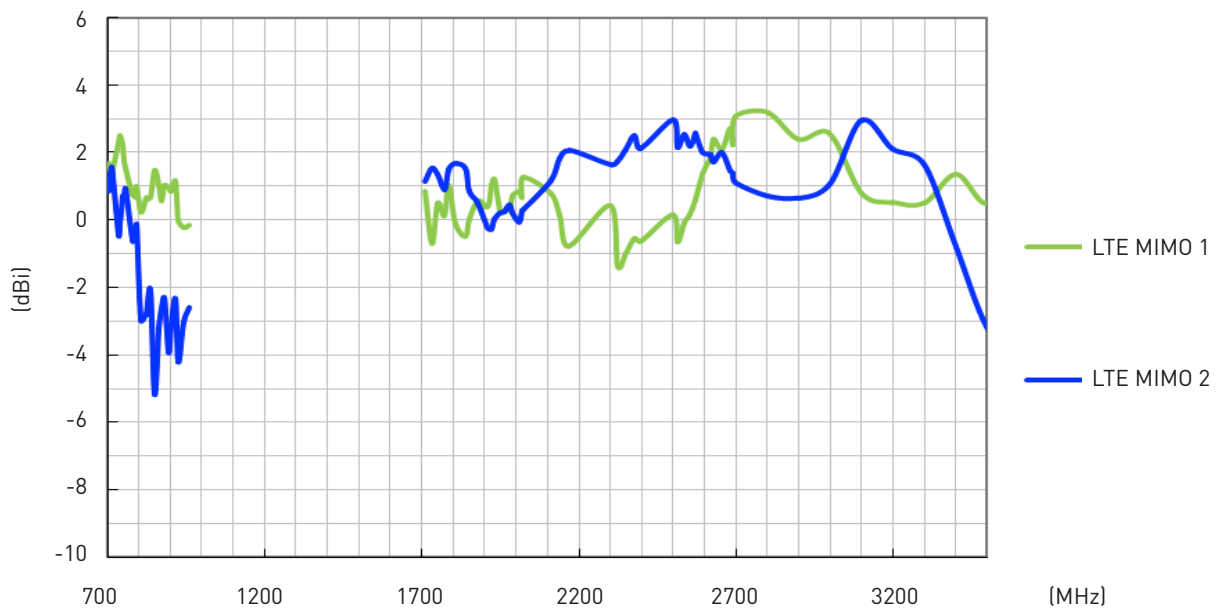

3. LTE MIMO

3.1 LTE MIMO 1 and LTE MIMO 2 Specification

3.1.3 Average Gain

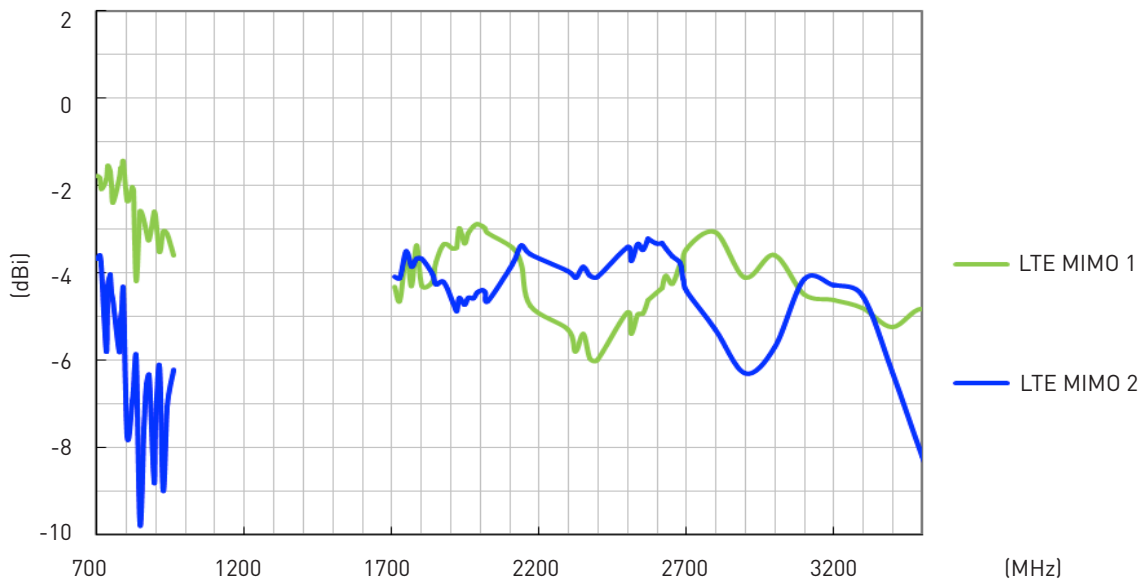

3.1.4 Efficiency

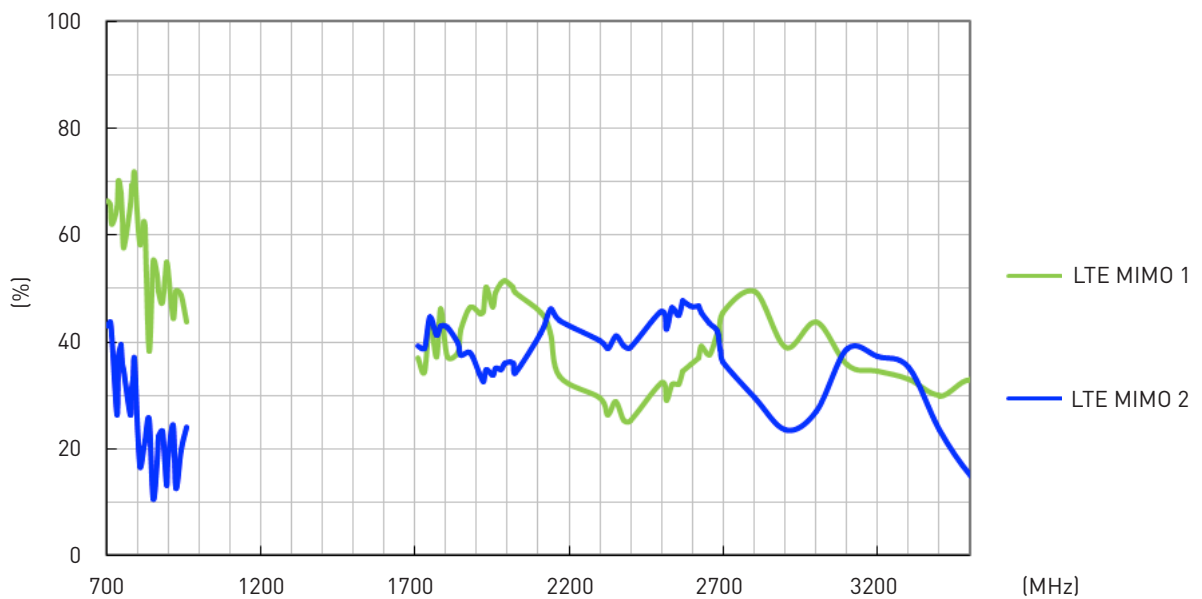

3.2 Radiation Patterns



3.2.1 LTE MIMO 1 Radiation Pattern

XY Plane

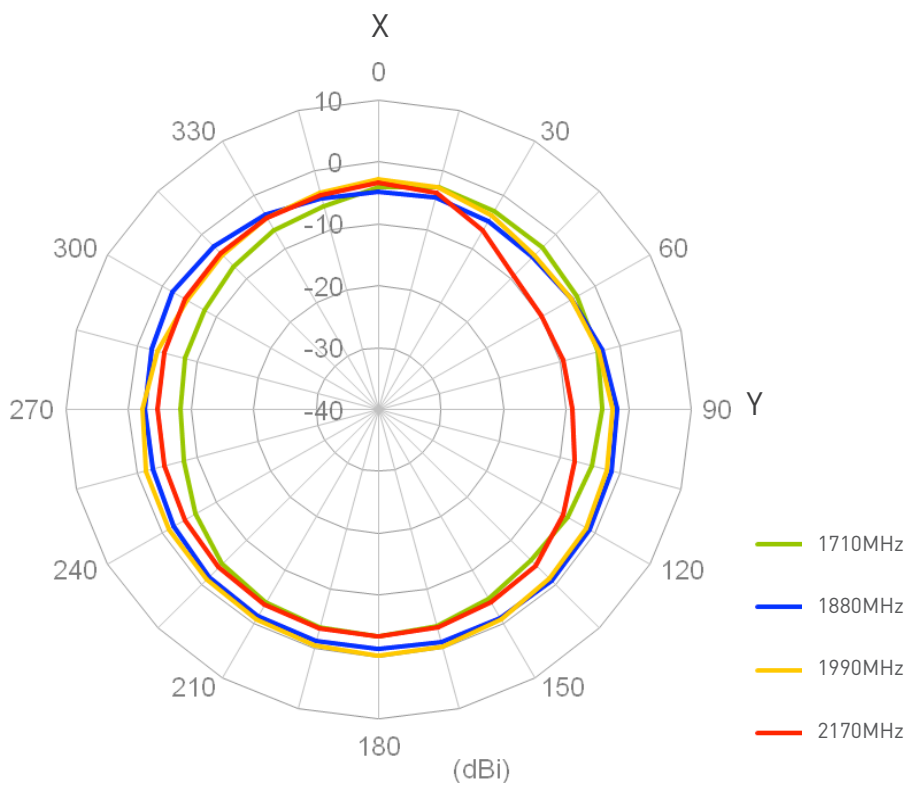
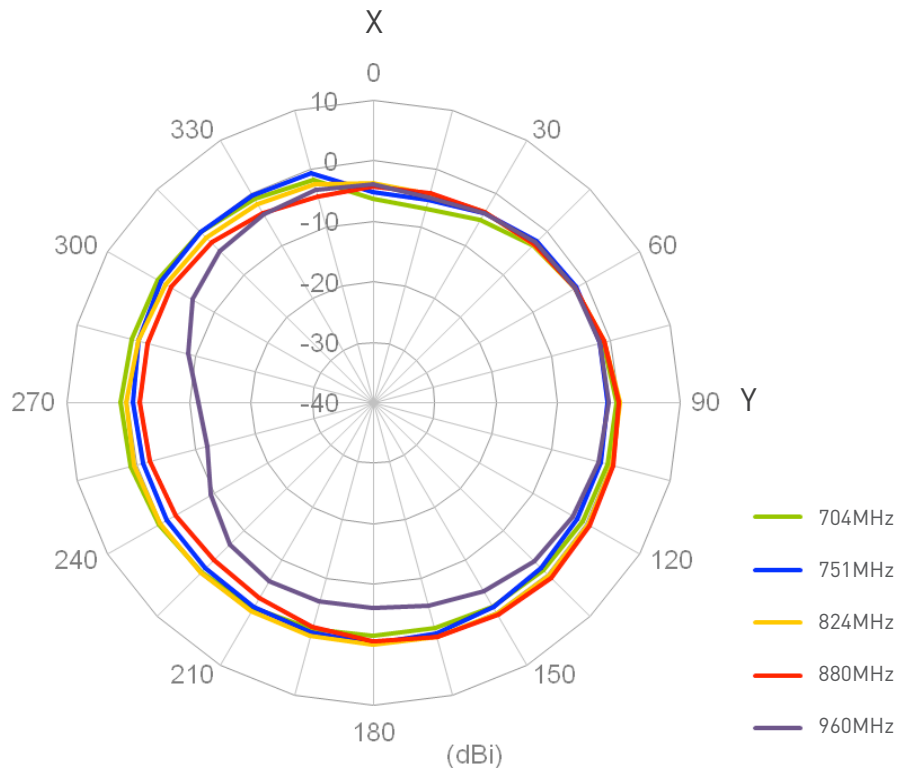

3.2.1 LTE MIMO 1 Radiation Pattern

XY Plane

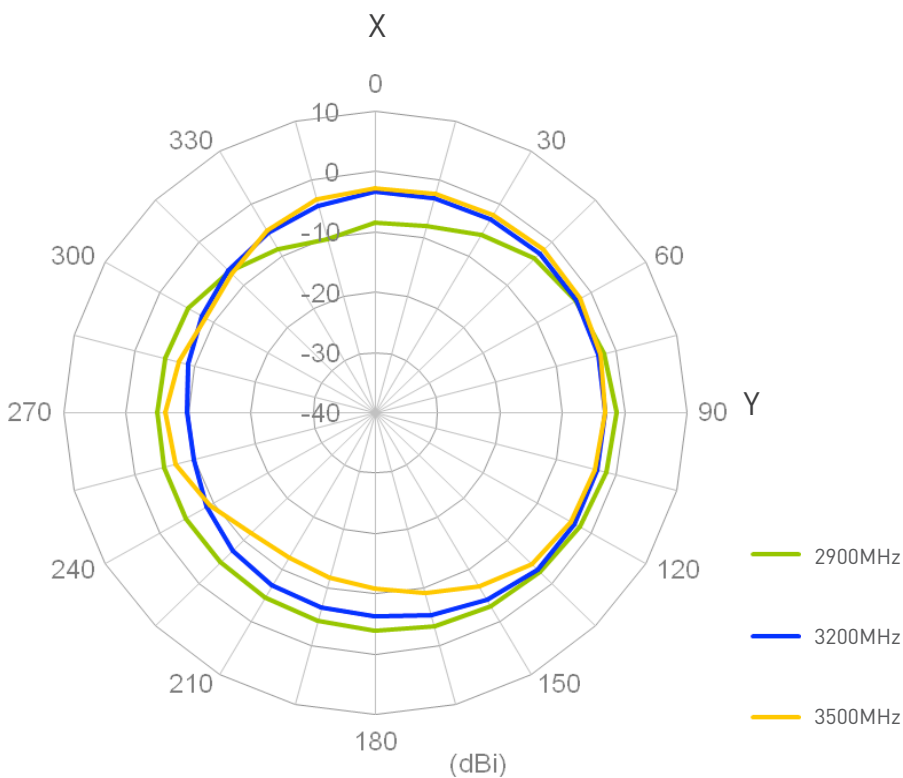
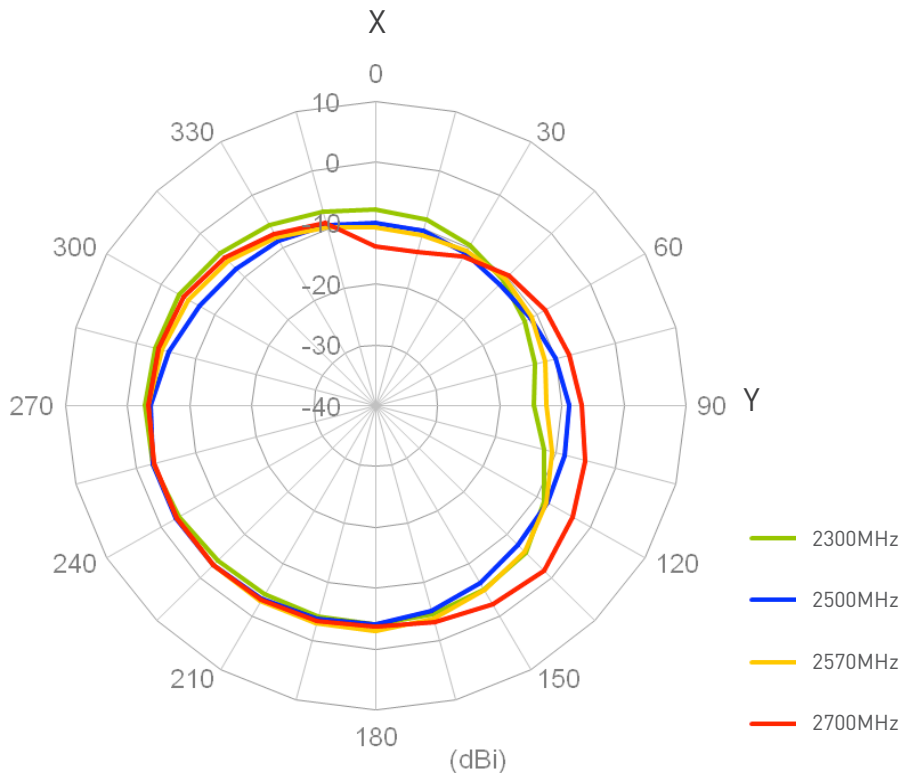

3.2.1 LTE MIMO 1 Radiation Pattern

XZ Plane

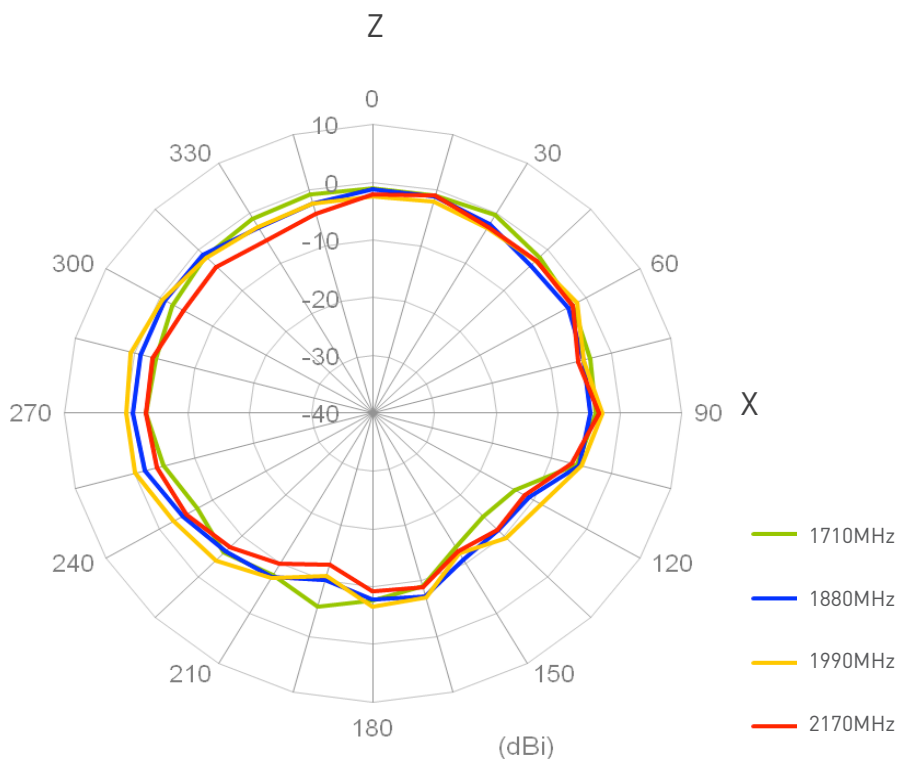
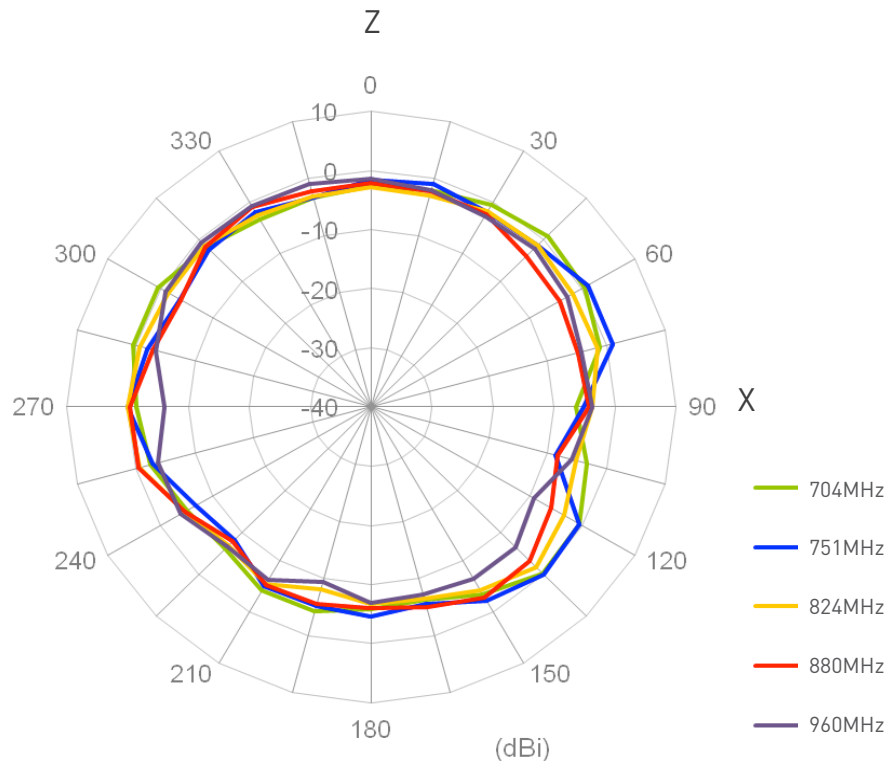

3.2.1 LTE MIMO 1 Radiation Pattern

XZ Plane

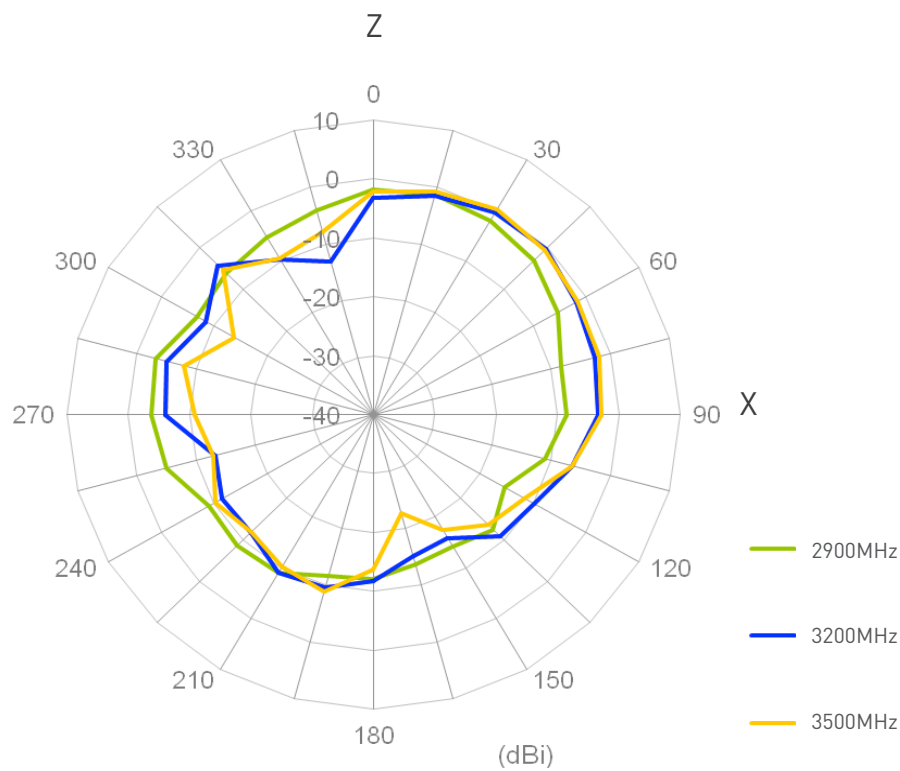
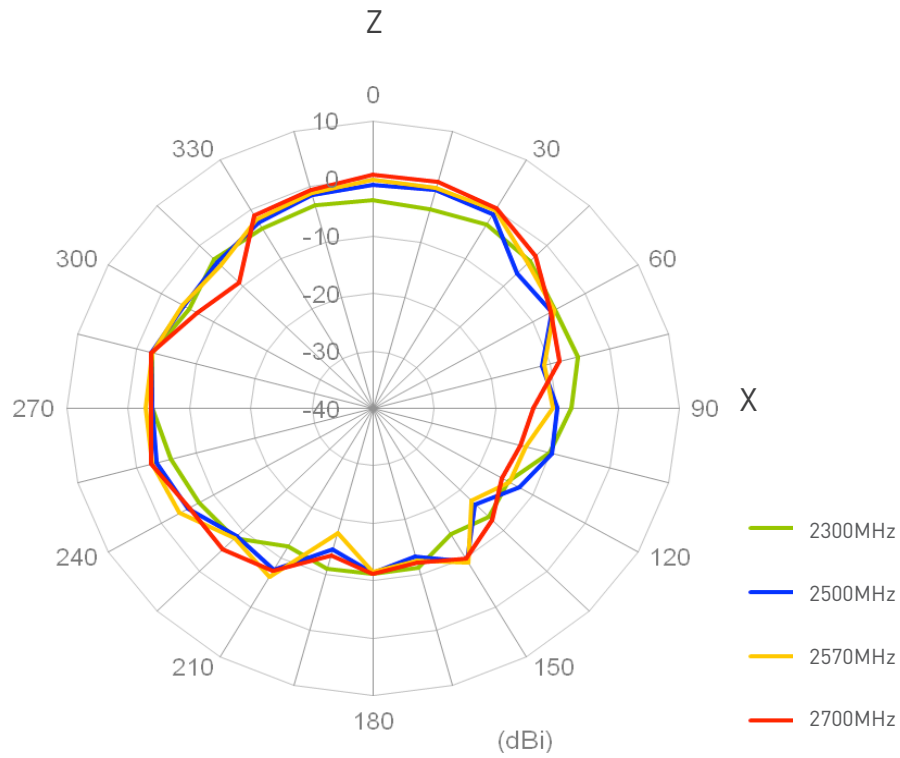

3.2.2 LTE MIMO 2 Radiation Pattern

XY Plane

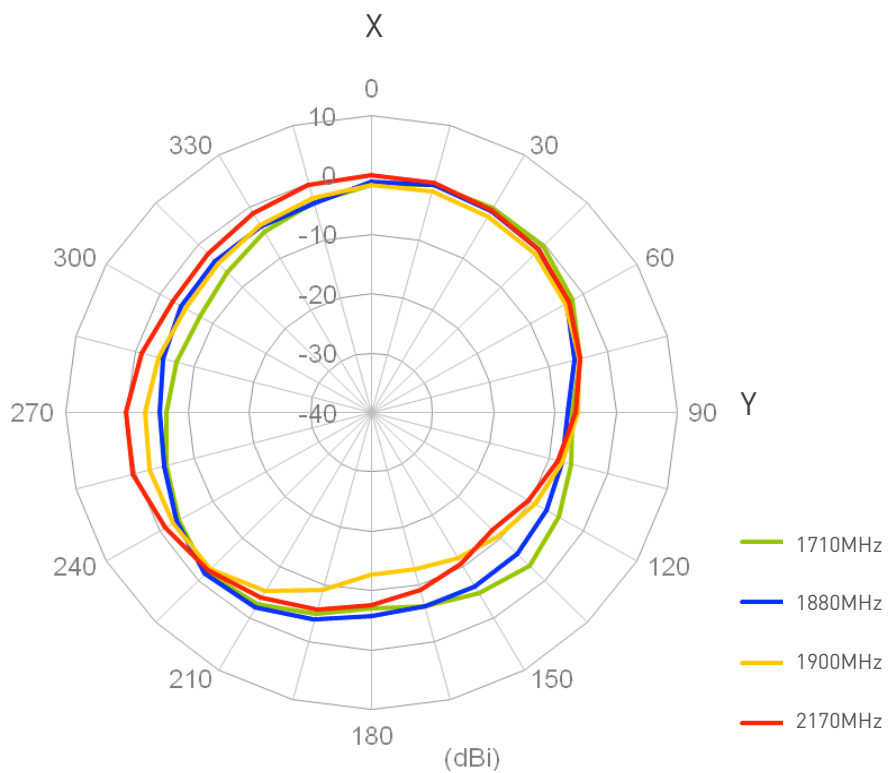
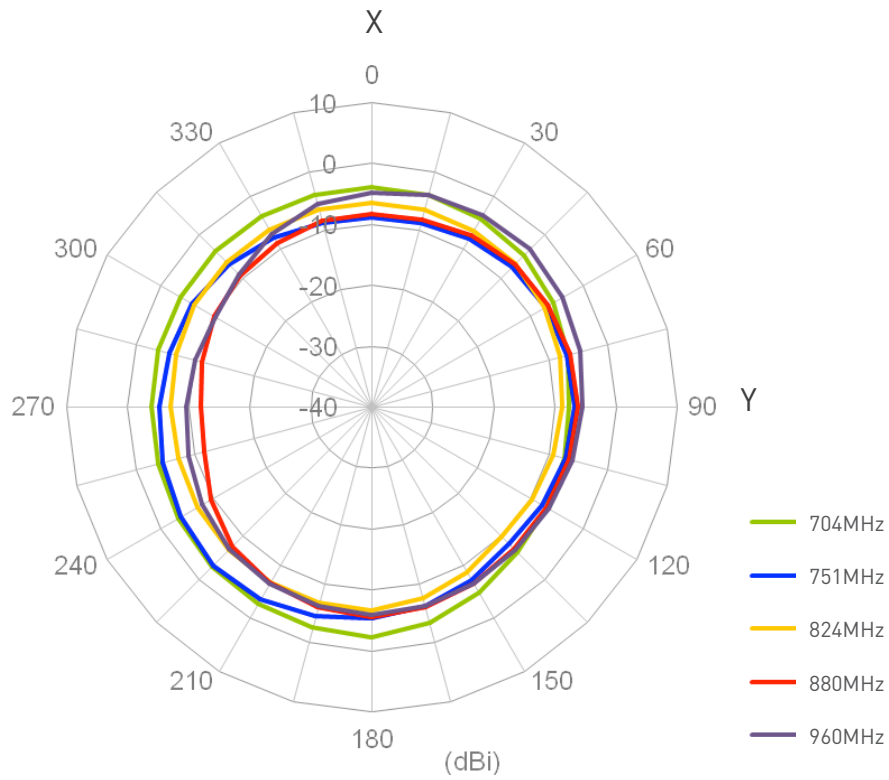

3.2.2 LTE MIMO 2 Radiation Pattern

XY Plane

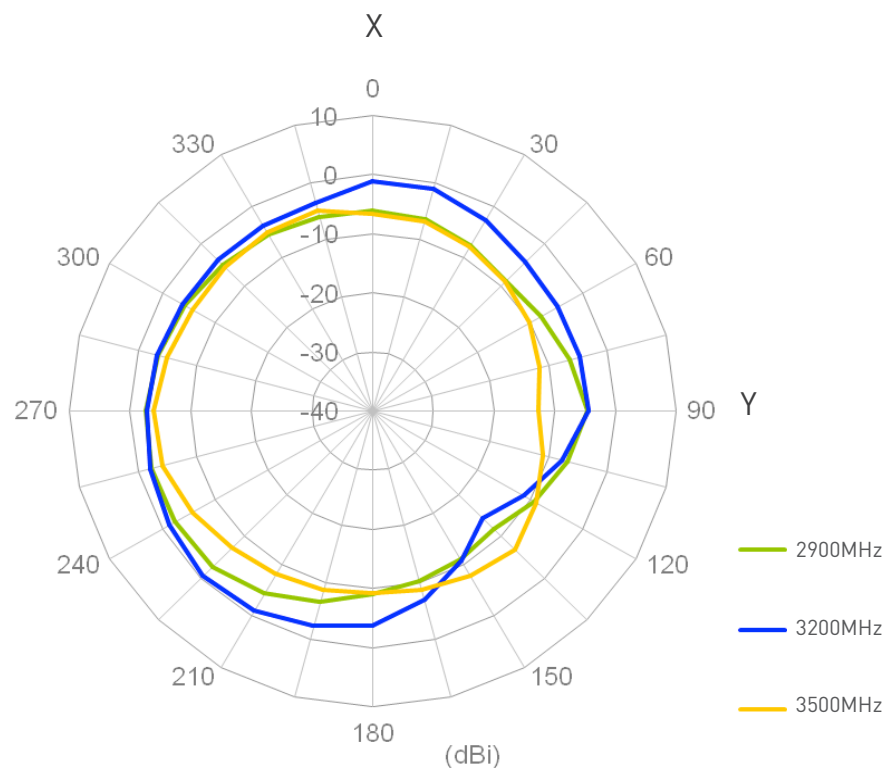
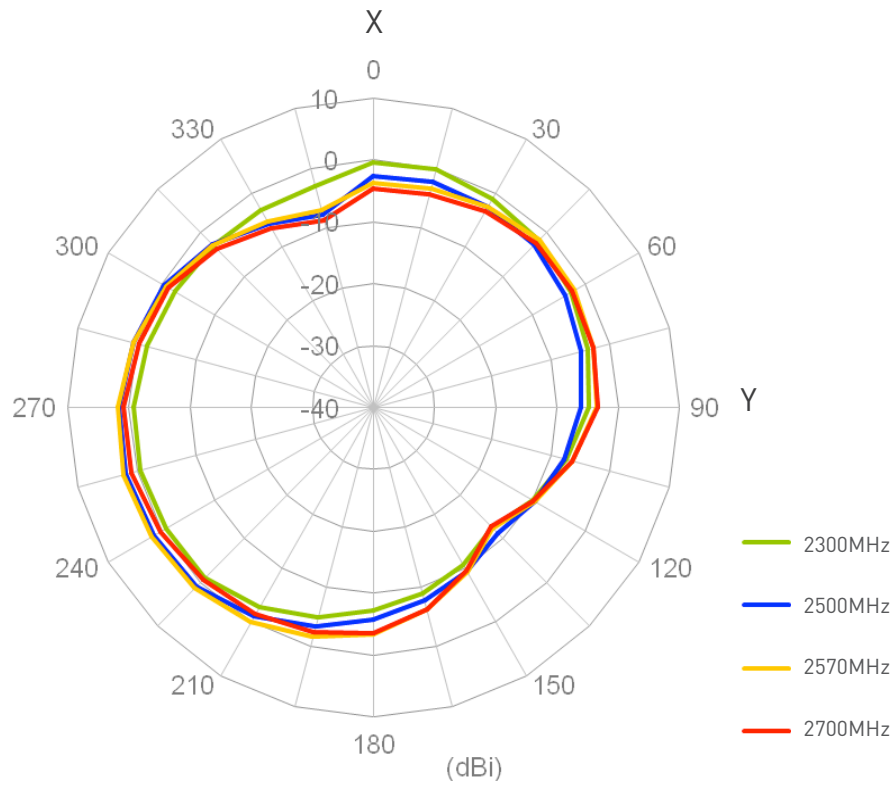

3.2.2 LTE MIMO 2 Radiation Pattern

XZ Plane

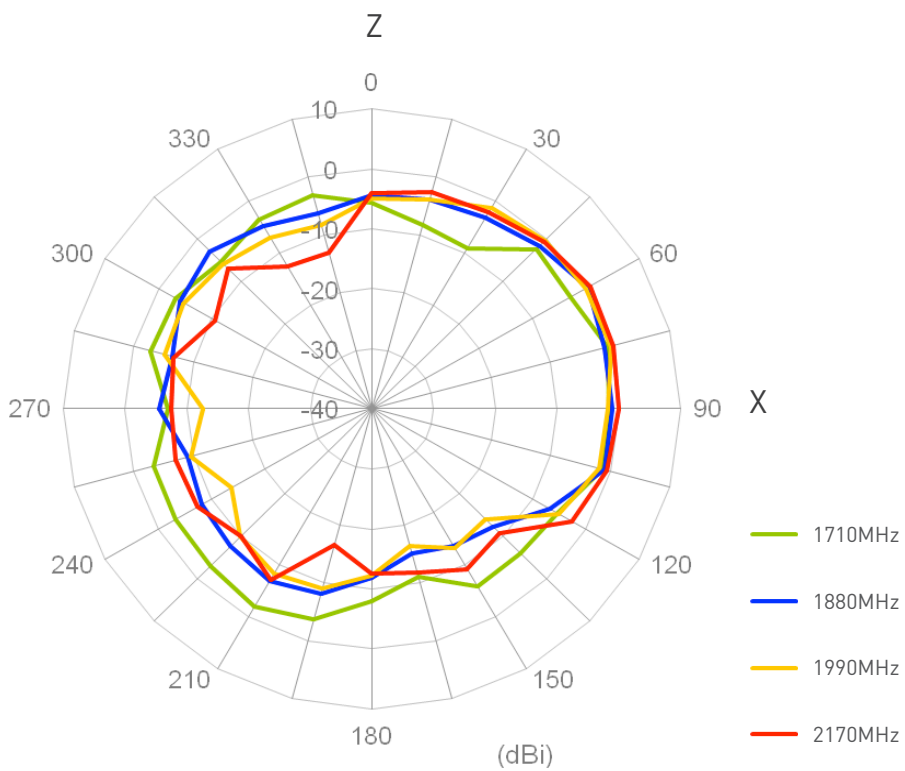
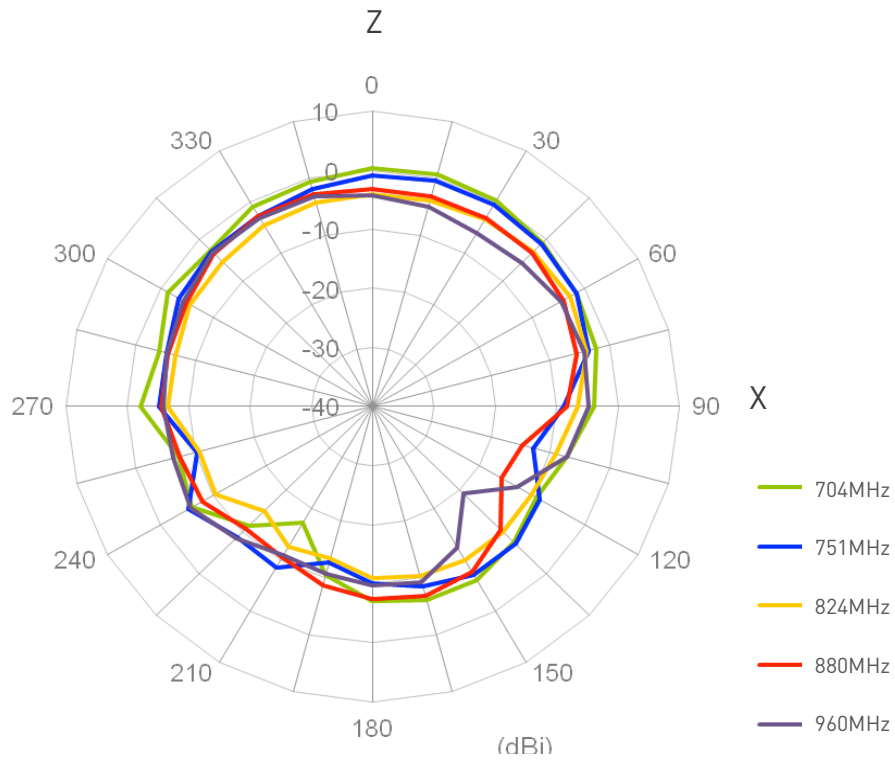

3.2.2 LTE MIMO 2 Radiation Pattern

XZ Plane

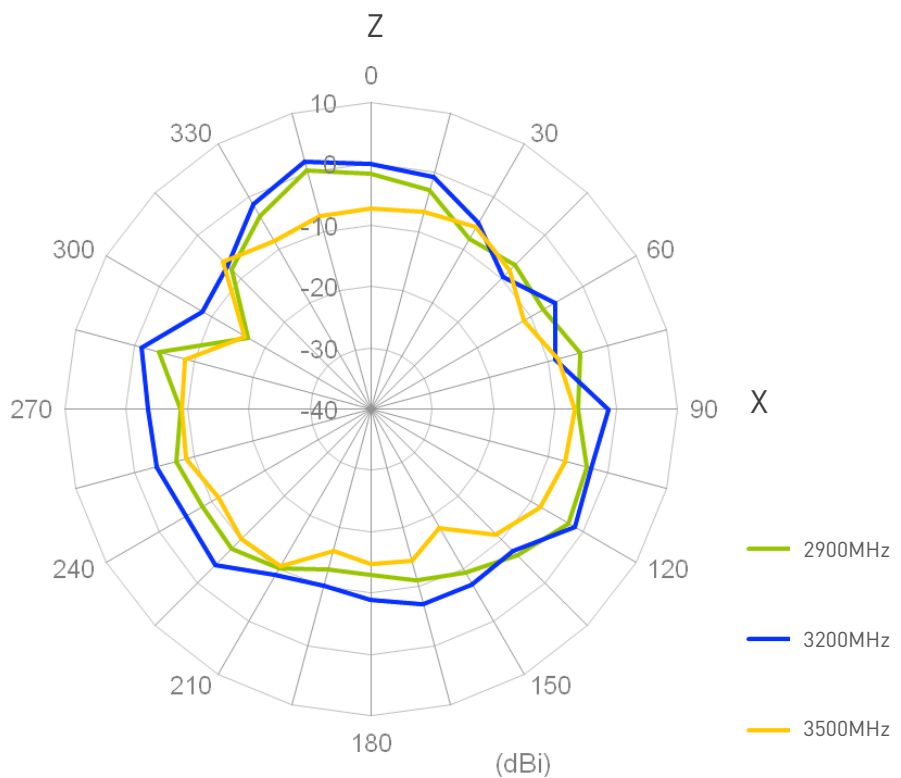
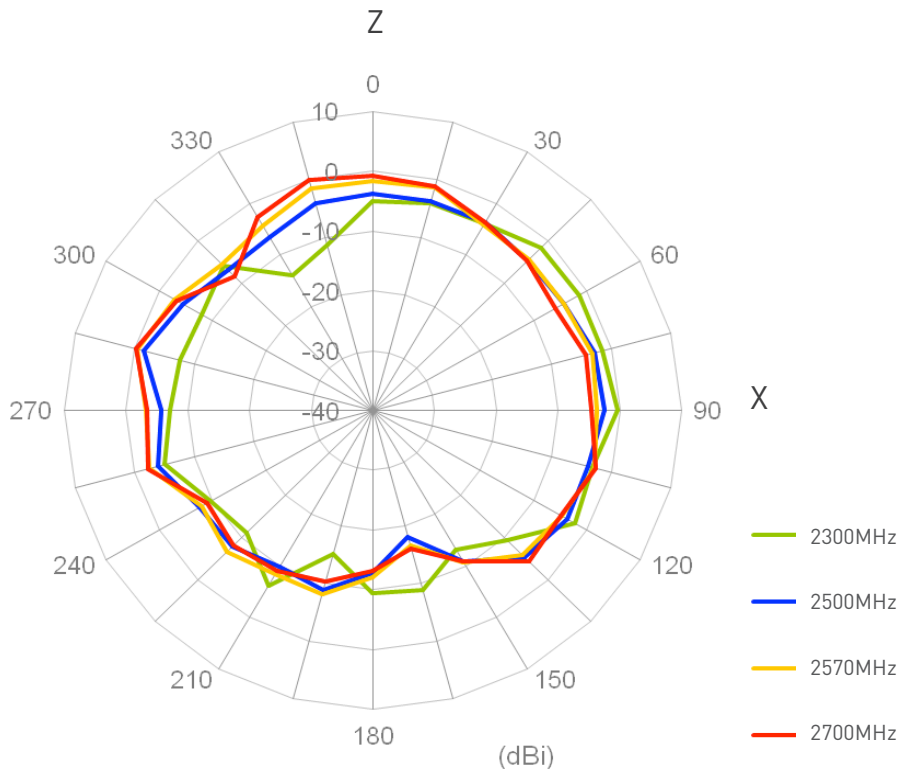

4. Wi-Fi 2.4 / 5GHz

4.1 Return Loss

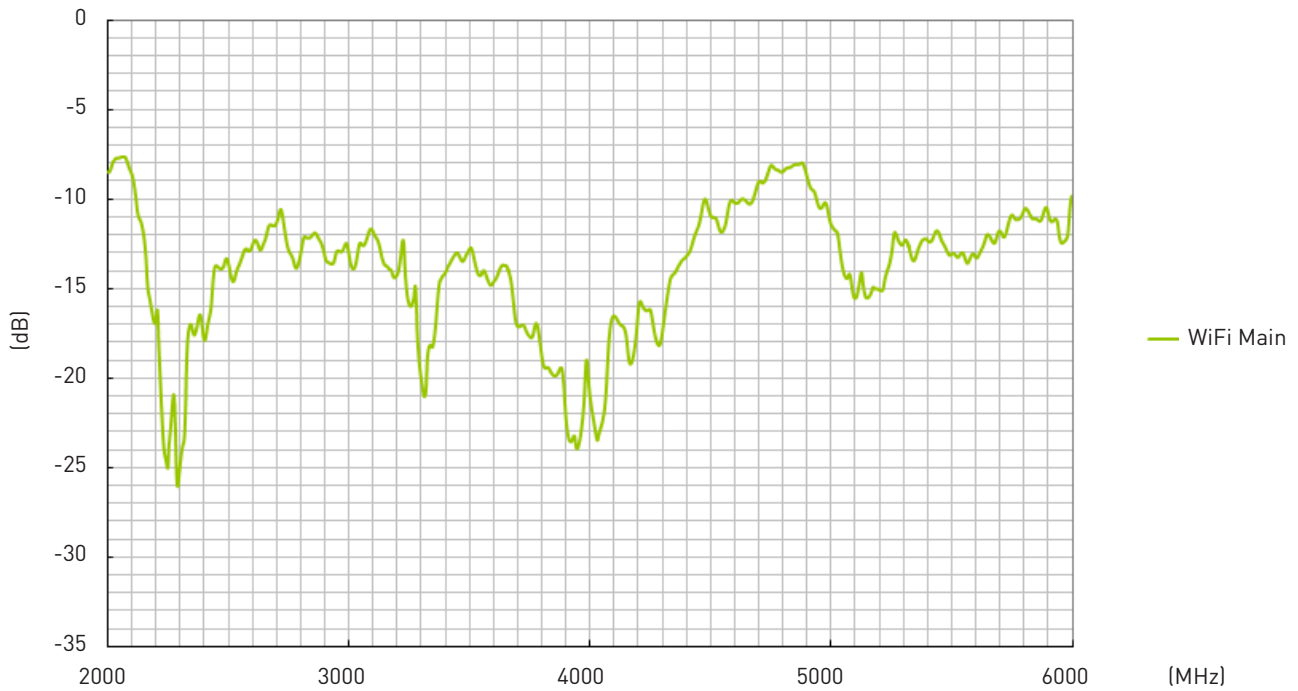

4.2 Maximum Gain

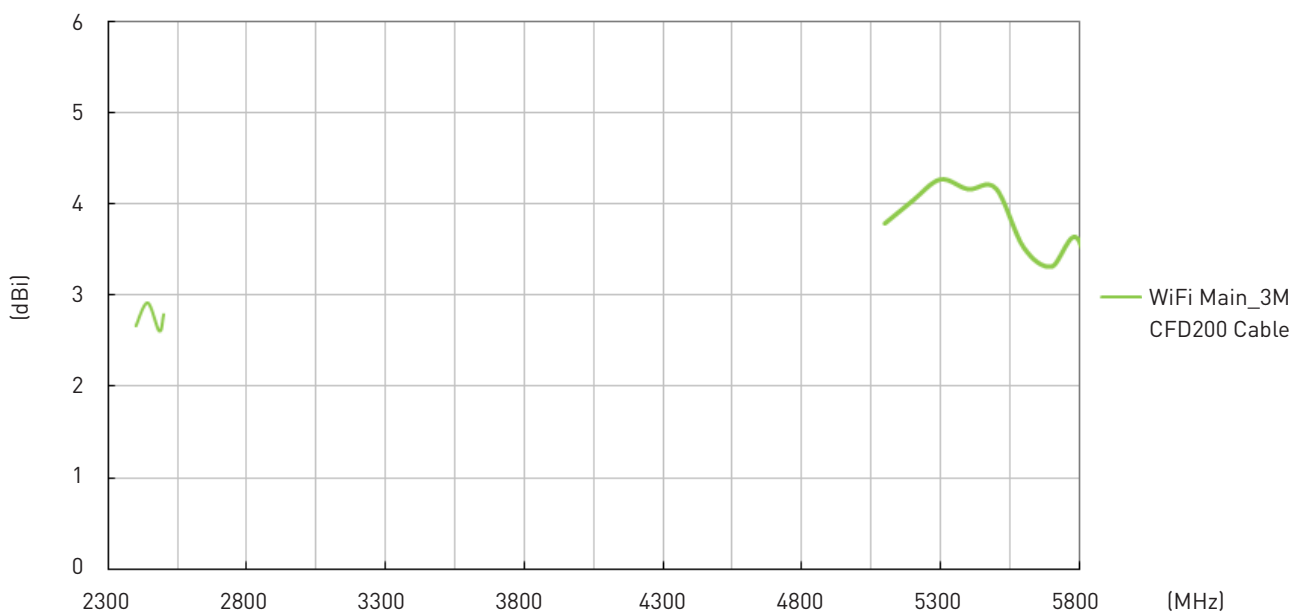

4. Wi-Fi 2.4 / 5GHz

4.3 Average Gain

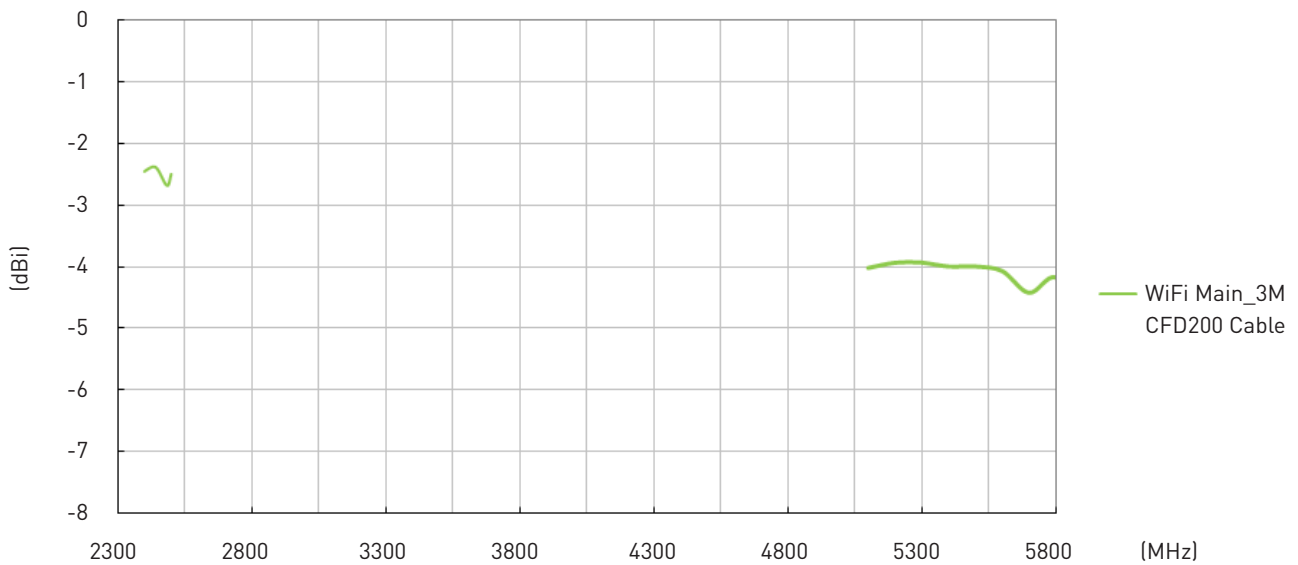

4.4 Efficiency

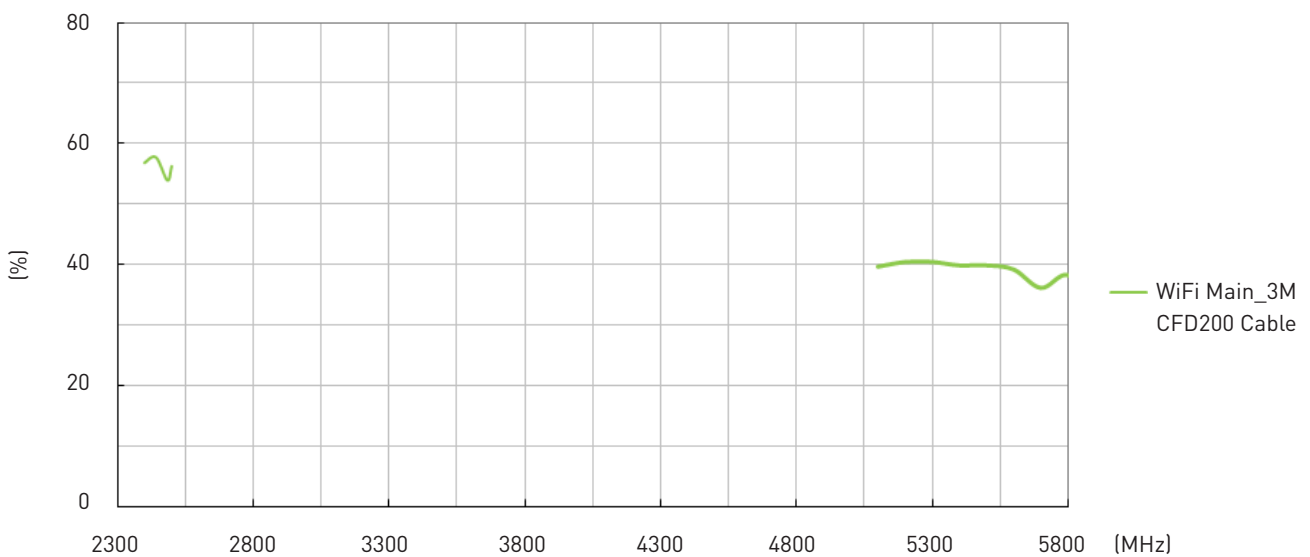

4. Wi-Fi 2.4 / 5GHz

4.5 Radiation Patterns

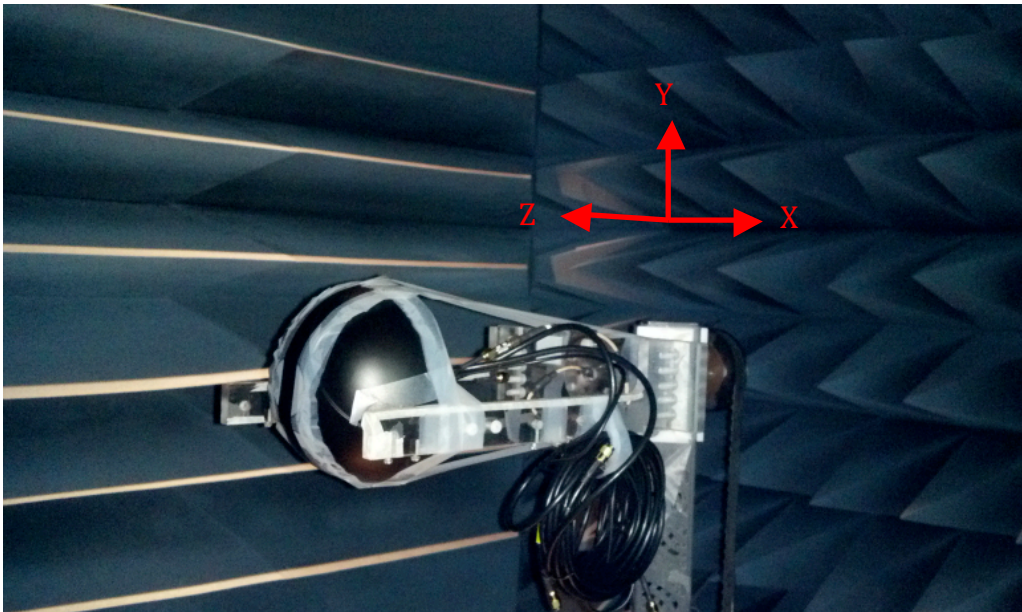

XY Plane

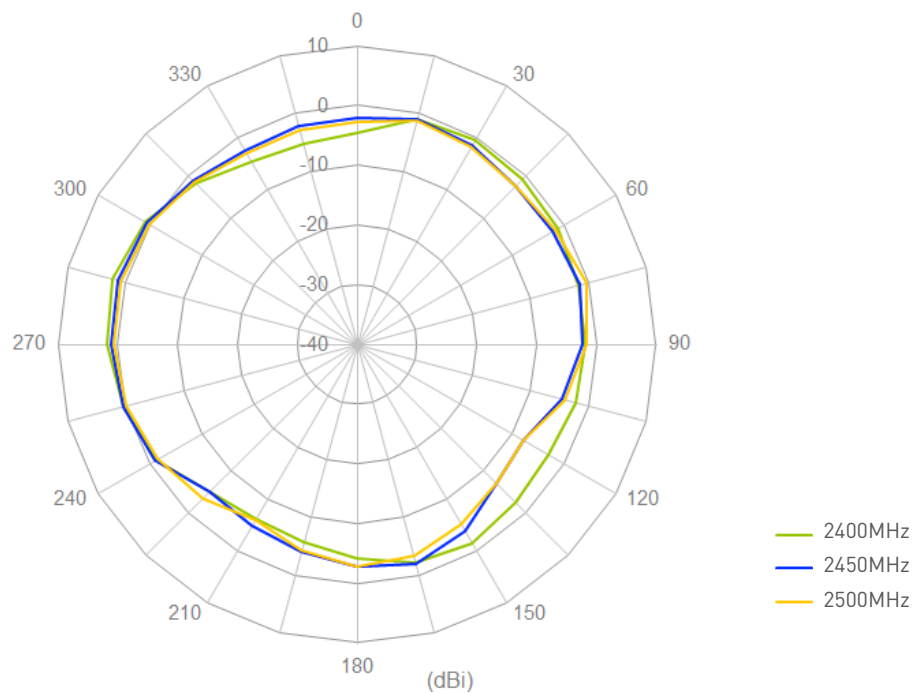

4. Wi-Fi 2.4 / 5GHz

4.5 Radiation Patterns

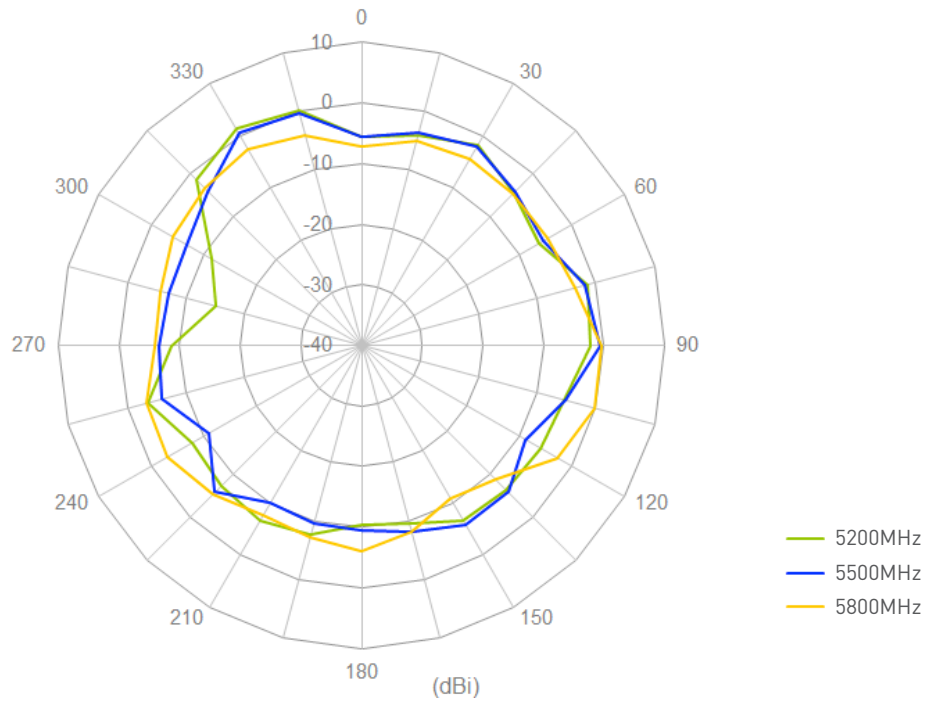

XZ Plane

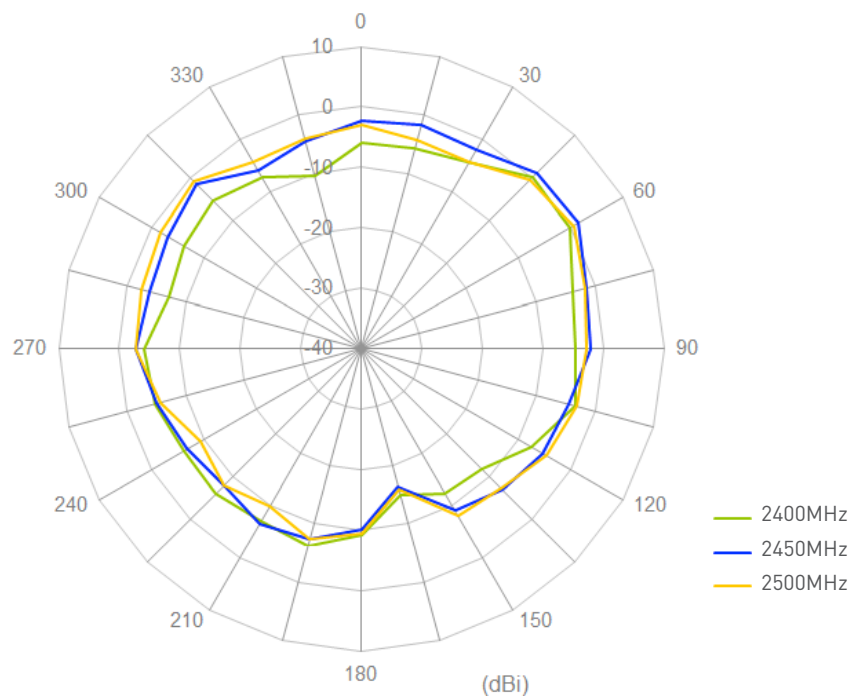

4. Wi-Fi 2.4 / 5GHz

4.5 Radiation Patterns

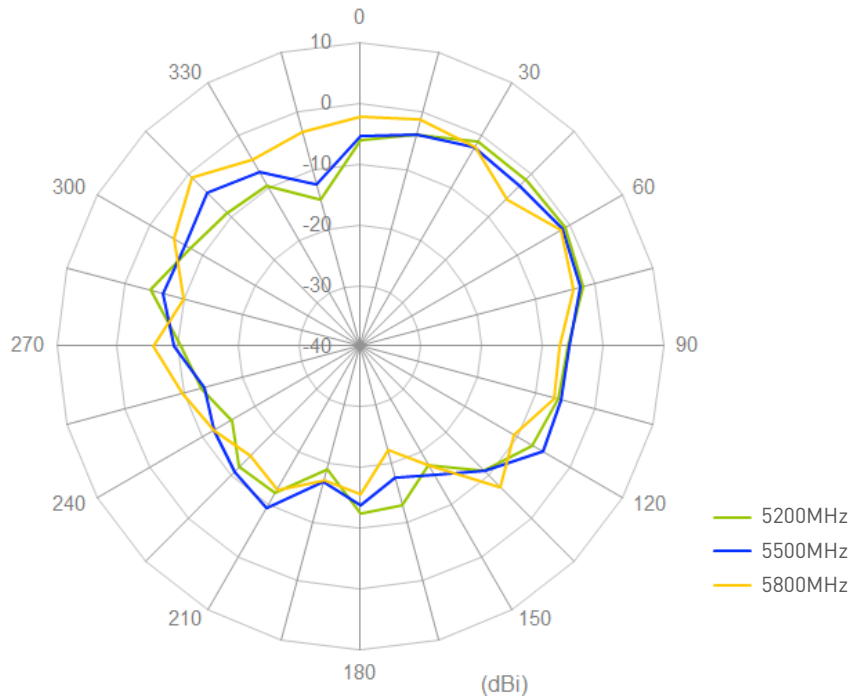

5. GPS/GLONASS

5.1 Block Diagram

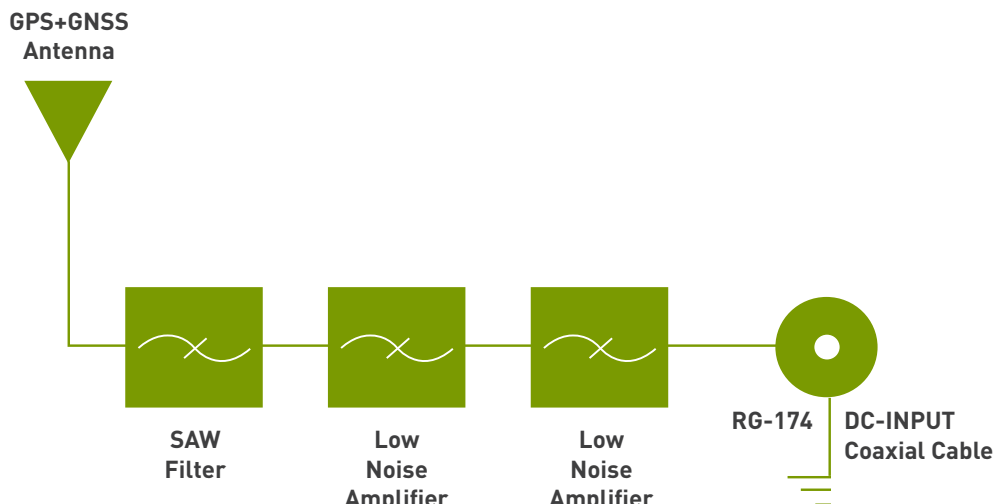

5. GPS/GLONASS

5.2 Return Loss

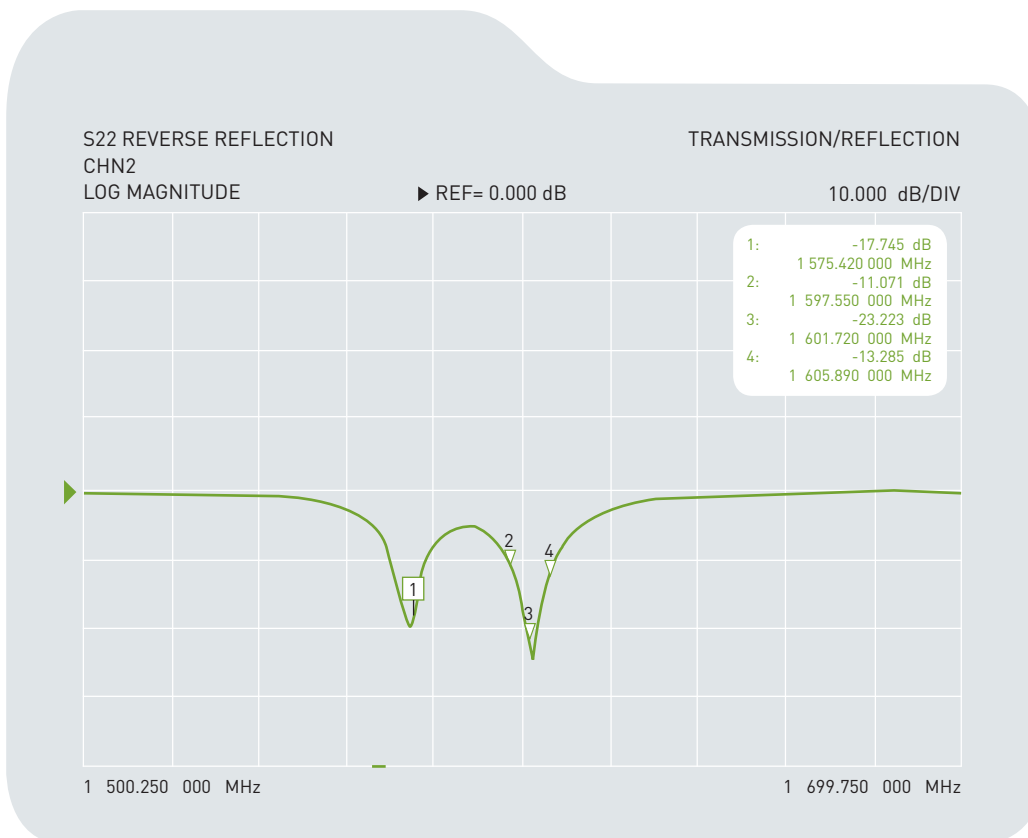

5.3 Radiation Pattern

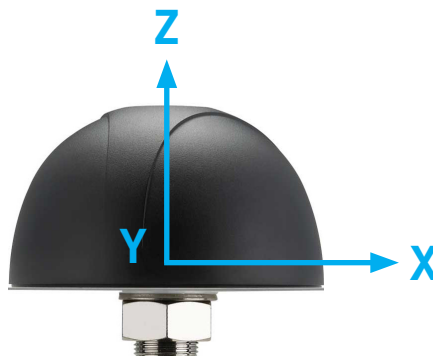

XYZ co-ordinate for reference

XZ-plane Free Space @1575.42MHz

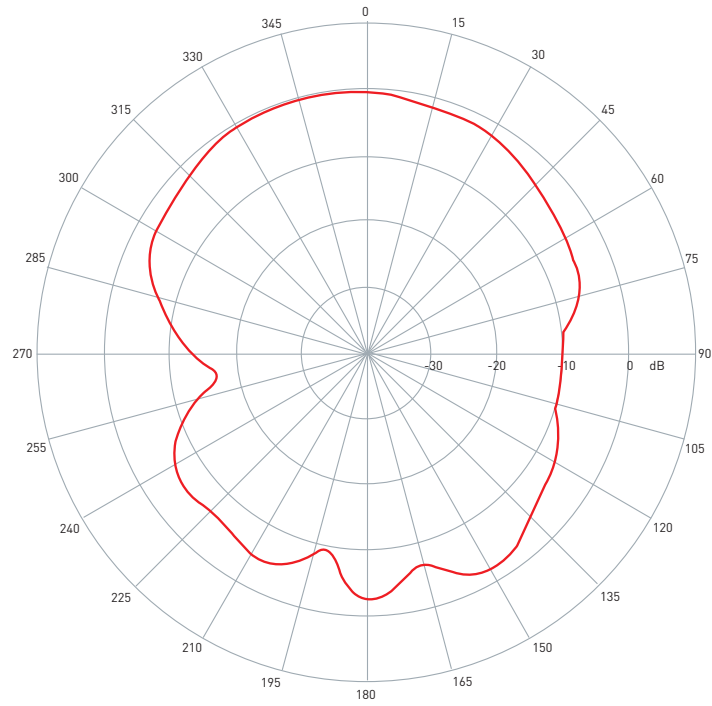

YZ-plane Free Space @1575.42MHz

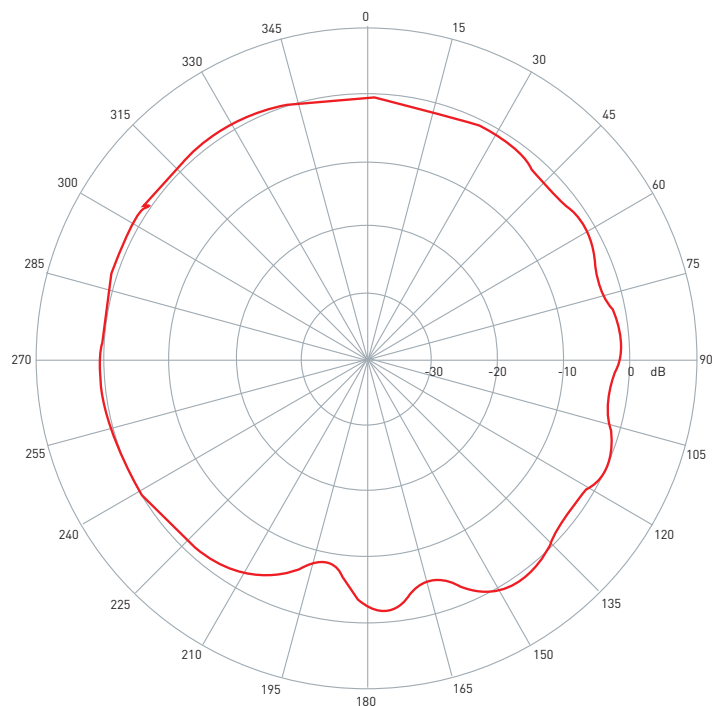

XZ-plane Free Space @1602MHz

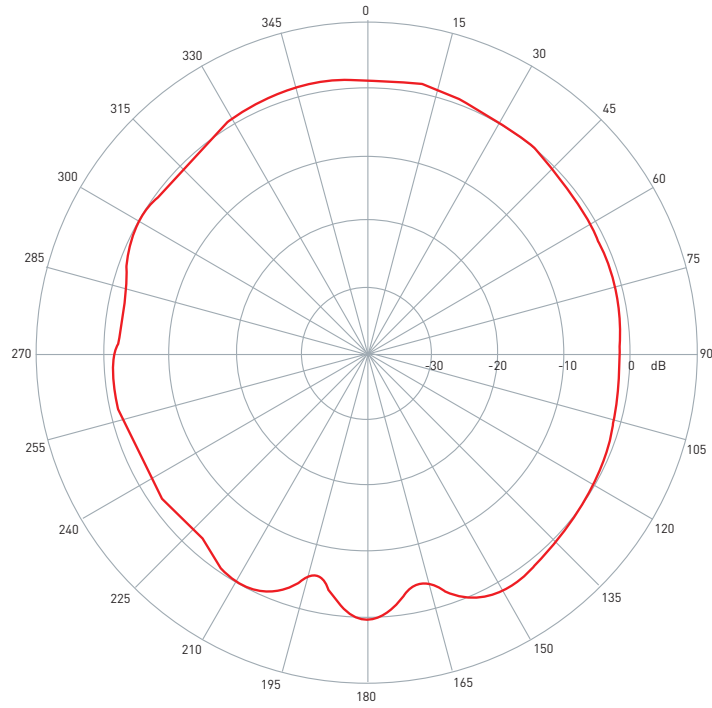

YZ-plane Free Space @1602MHz

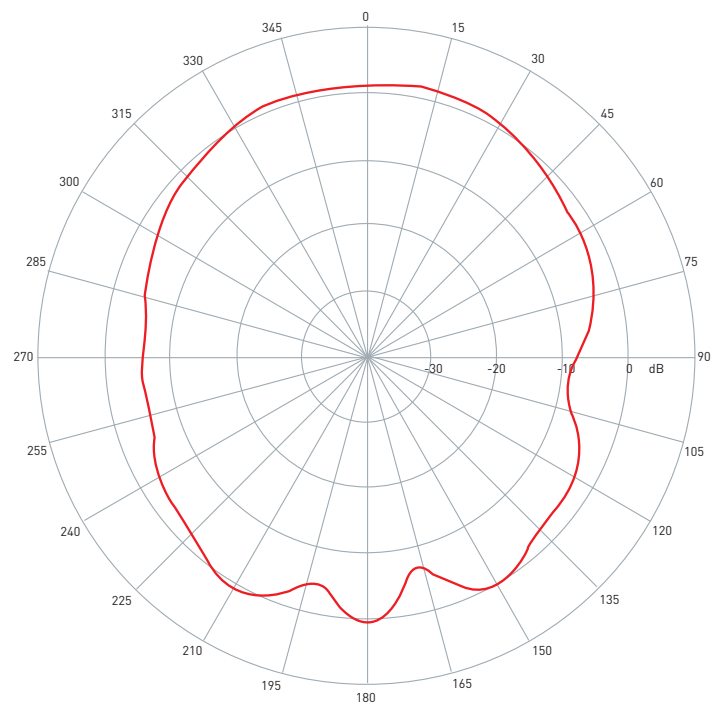

5.4 GPS/GLONASS LNA

S21 Forward Transmission

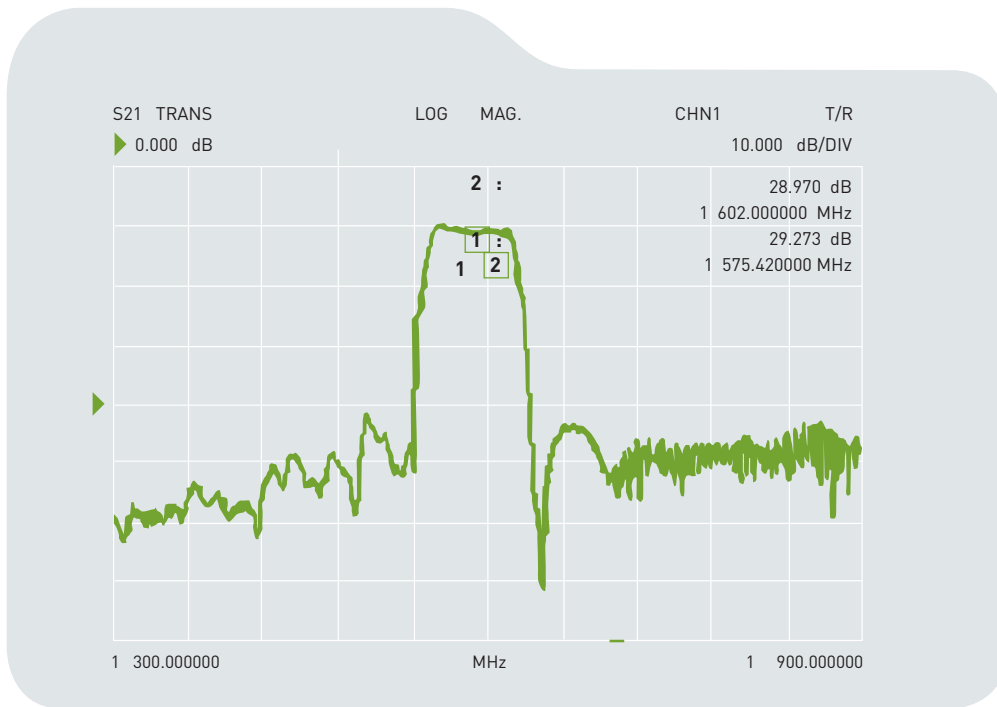

S22 Reverse Reflection

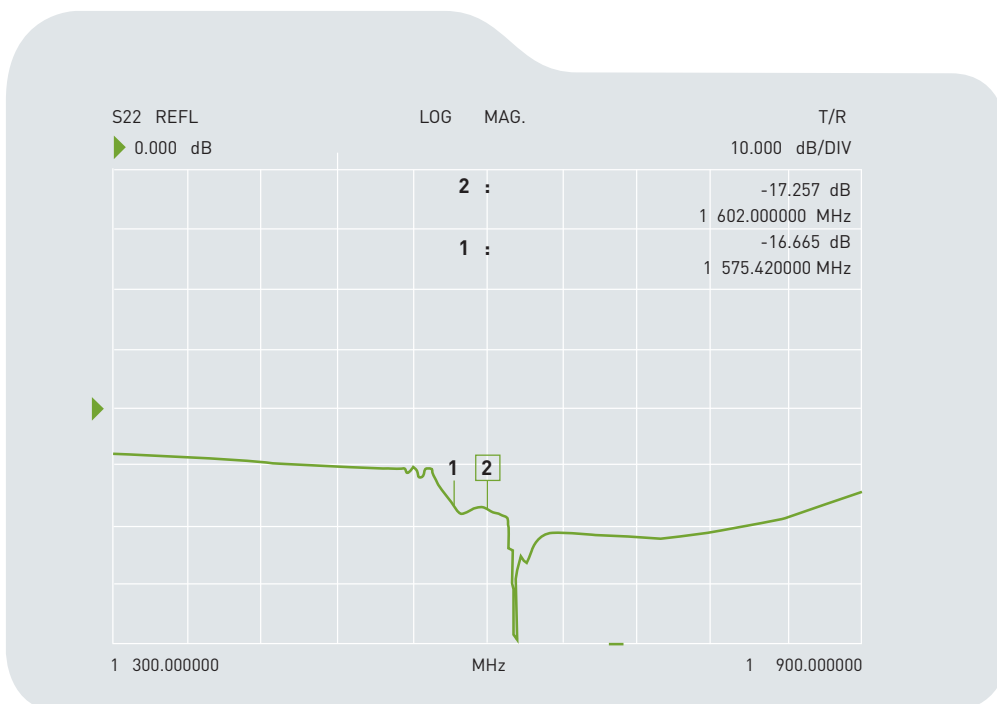

6. Drawing

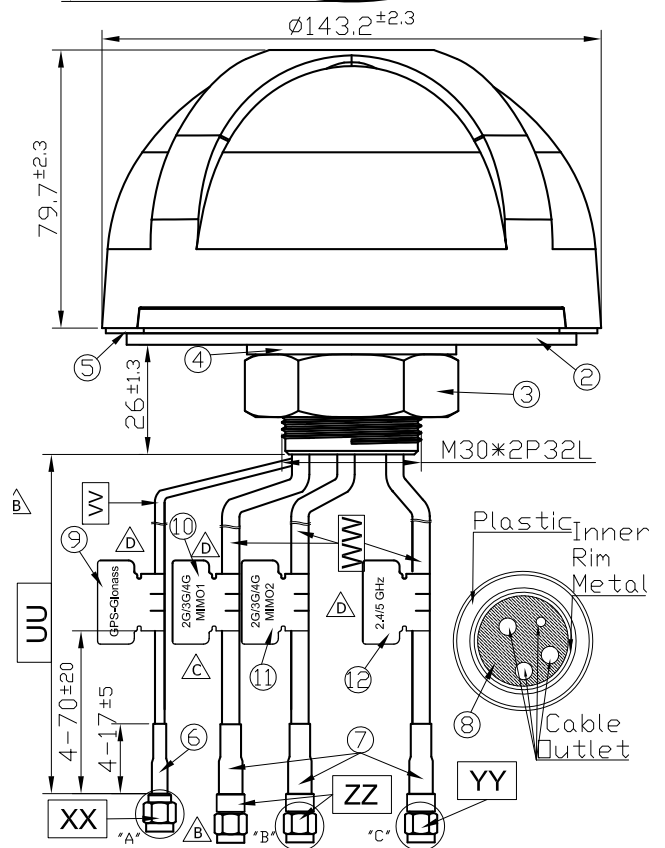
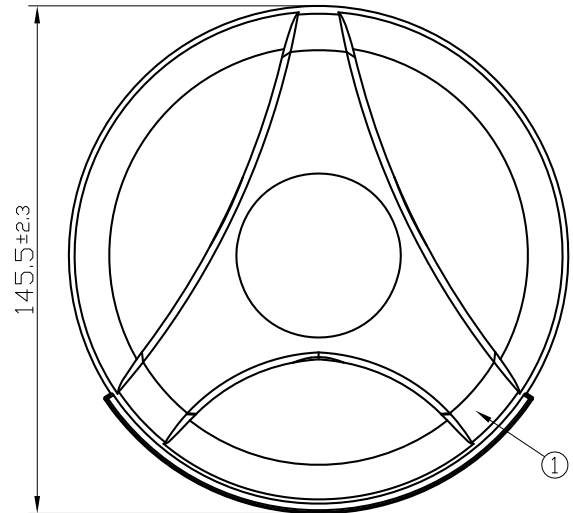
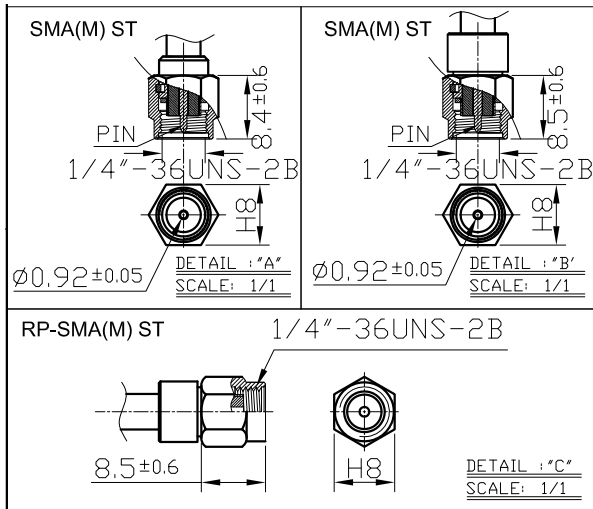

	Name	Material	Finish	QTY
1	Housing	PC 540	Black	1
2	Closed Cell Foam	CR 4305	Black	1
3	M30 Nut	Steel AISI 1215	Ni Plated	1
4	Washer	Steel AISI 1215	Ni Plated	1
5	Waterproof Gasket	Silicon Rubber	Black	1
6	Heat Shrink Tube	PE (RG174)	Black	1
7	Heat Shrink Tube	PE (CFD200)	Black	3
8	Rubber Stopper	Silicon Rubber	Black	1
9	GPS-Glonass Label	Coated Paper	Orange	1
10	2G/3G/4G MIMO1 Label	Coated Paper	Gray	1
11	2G/3G/4G MIMO2 Label	Coated Paper	White	1
13	2.4/5 GHz Label	Coated Paper	Green	1

	Name	Spec	Finish	QTY
UU	Cable Length	3000mm±120mm		
VV	Cable Type	RG174	Black	1
WW	Cable Type	CFD200	Black	3
XX	Connector Type	SMA(M) ST	Gold	1
YY	Connector Type	RP-SMA(M) ST	Gold	1
ZZ	Connector Type	SMA(M) ST	Gold	2

7. Packaging

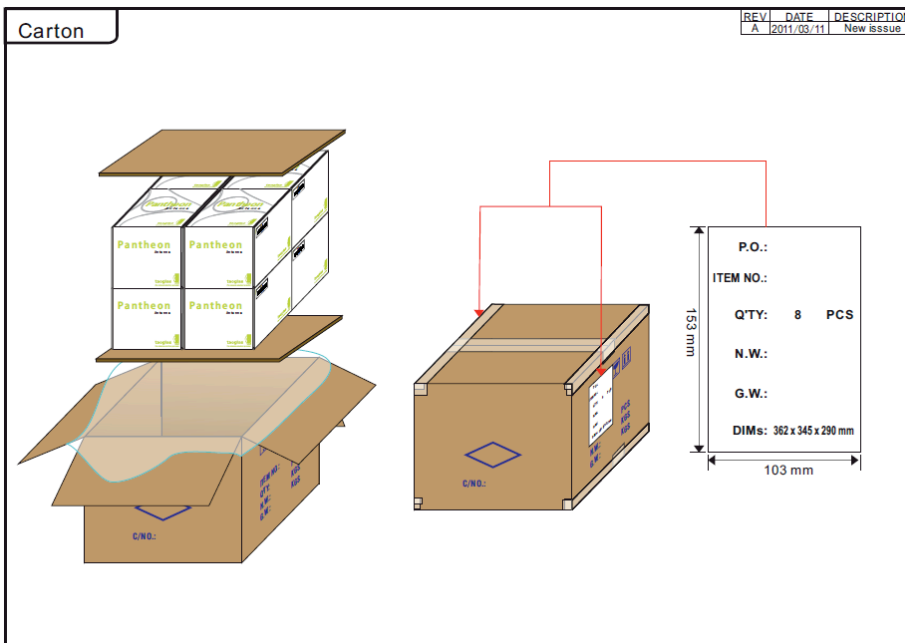
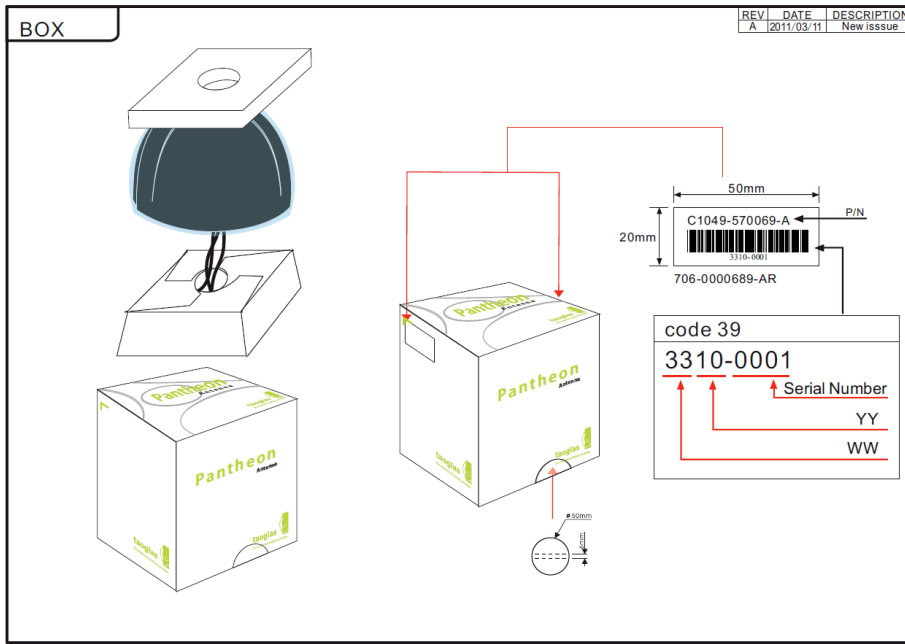

Taoglas makes no warranties based on the accuracy or completeness of the contents of this document and reserves the right to make changes to specifications and

product descriptions at any time without notice. Taoglas reserves all rights to this document and the information contained herein.

Reproduction, use or disclosure to third parties without express permission is strictly prohibited.
Copyright © Taoglas Ltd.