

## ▶▶▶ Industrial RTU

### PRODUCT HIGHLIGHTS

- Datalogging and timestamping, trending, alarm logging, and sequence of events
- Stand alone control of remote sites IEC 61131 ISaGRAF and high level C++ programming
- Limitless multi-user connectivity; telephone, Internet, and wireless telemetry, 10/100 Ethernet plus up to 4 com ports
- Advanced communication capabilities report on exception, store & forward, peer to peer
- True open system design, Ethernet TCP, Modbus, Linux, OPC & more
- Small to large applications, scalable from 1 to 1,000+ stations
- Embedded Linux open source software, add applications, I/O drivers & much more
- An OEM's dream platform, pre-certified, add your application

### PERFORMANCE SPECIFICATIONS

- Industrial powerPC (32 bit data bus)
- Operating system embedded Linux
- Dynamic memory (RAM) up to 32 Mbytes - 32bit, 0 wait states
- Program memory (Flash) up to 64 Mbytes
- Retained memory (RAM) 512K (battery-backed)
- Local I/O (on-board) 26 (see ordering info.)
- Unlimited I/O expansion
- Datalogging support
- IEC 61131 programming
- High Level C programming, Linux open source

### ETHERNET PORT

- 10/100BaseTx (auto-detecting)
- RJ45 connection (auto-crossover)
- Protocols TCP/IP, ARP, UDP, ICMP, DHCP, Modbus/TCP, Sixnet, and more

### SERIAL PORT

- RS485 port A & C screws (485+, 485-, GND) (2-wire half-duplex)
- RS232 port B RJ45 (TD, RD, CTS, RTS, CD, DTR, DSR, GND)
- RS232 port D screws (TD, RD, RTS)
- Protocols (master & slave) Sixnet & Modbus RTU/ASCII; many others available in Linux
- Flow control hardware, software, RTS-party (for radios and RS485)

### DISCRETE INPUTS

- 12 channels (sinking or sourcing)
- Guaranteed ON voltage 9 VDC
- Maximum voltage 30 VDC
- Guaranteed OFF voltage & current 5.0 VDC & 1.5 mA DC
- Input resistance 10K Ohms
- Input current @ 24 VDC 3 mA
- Filtered ON/OFF delay 25 mS (20 Hz max. counting)
- Fast ON/OFF delay 4 mS (100 Hz max. counting)
- Count rate (channels 1 - 8) see above (10 KHz on channel 1)

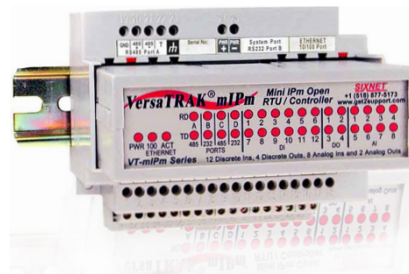

### DISCRETE OUTPUTS

- Up to 8 channels (10-30 VDC)
- Maximum output per channel 1 Amp
- Maximum output per module 8 Amps
- Max. OFF state leakage 0.05 mA
- Minimum load 1 mA
- Inrush current 5 Amps (100 mS surge)
- Typical ON resistance 0.3 Ohms
- Typical ON voltage (@1A) 0.3 VDC

### ANALOG INPUTS

- Up to 8 channels (4-20 mA)
- A/D resolution 16 bits (0.003%)
- Full scale accuracy +/-0.1% (@20°C)
- Span and offset temp. coef. +/-50 ppm per °C
- Input impedance 100 Ohm
- Current protection Self-resetting fuses
- DMRR (differential mode rejection) 66 dB at 50/60 Hz

### ANALOG OUTPUTS

- up to 2 channels (4-20 mA)
- D/A resolution 16 bits (less than 1µA)
- Full scale accuracy (@20°C) +/- 0.02%
- Span and offset temp. coef. +/- 50 ppm per °C typical
- Max. output settling time 5 mS (to .05%)
- Load resistance range (@ +24 VDC supply) 0-750 Ohms
- Short circuit protection current limiting

### ENVIRONMENTAL

- DIN rail or flat panel mount
- Input power 10-30 VDC
- Input current 100 mA @ 24 VDC (typical)
- Temperature -40 to 70°C (-40 to 85°C storage)
- Humidity 5% to 95% RH (non-condensing)
- Flammability UL 94V-0 materials
- Electrical safety UL 508, CSA C22.2/14; EN610101; (IEC1010)
- EMI emissions FCC part 15, ICES-003, Class A; EN55022; EN61326-1
- EMC immunity EN61326-1 (EN61000-4-2,3,4,6)
- Vibration IEC68-2-6
- Hazardous locations (Class 1, Div 2, Groups A,B,C,D) UL 1604, CSA C22.2/213, Genelec EN50021 Zone 2

All specifications are subject to change. Consult factory for latest info.

## MECHANICAL DIMENSIONS

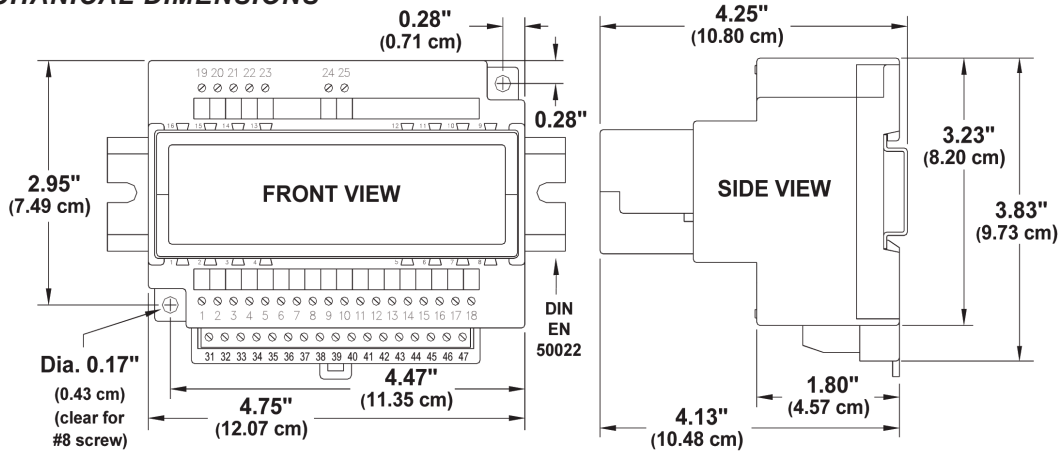

## WIRING DIAGRAM

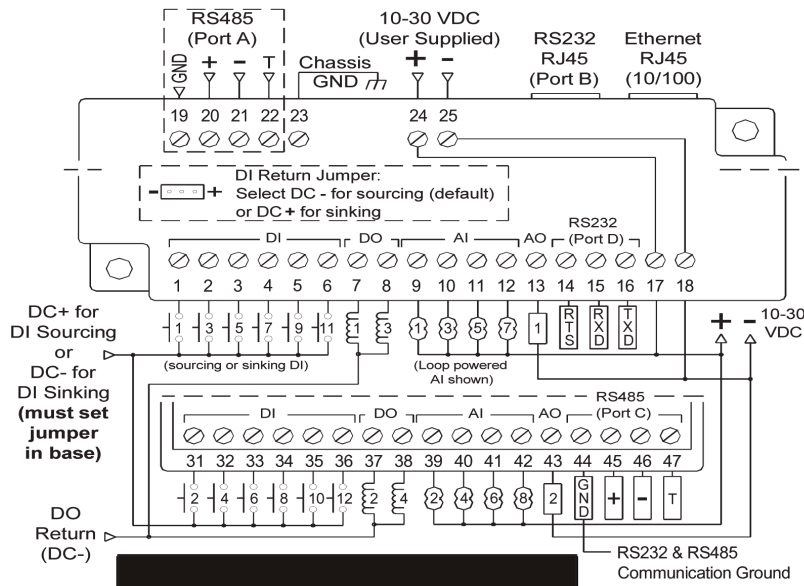

### Equivalent DC Input Circuits

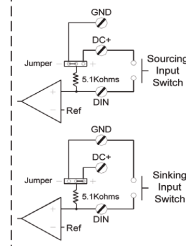

### Equivalent DC Output Circuit (sourcing only)

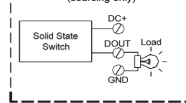

### Equivalent DC Output Circuit (sinking only)

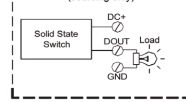

### Equivalent Analog (4-20 mA) Input Circuit

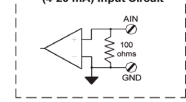

### Equivalent Analog (4-20 mA) Output Circuit

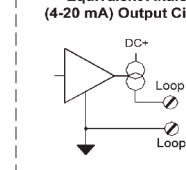

## ORDERING GUIDE

Model	DI	DO	AI	AO	RS232	RS485	Ethernet
VT-MIPM-131-D	12	8	6	0	2	1	10/100
VT-MIPM-135-D	12	8	6	0	2	1	10/100
VT-MIPM-241-D	12	4	8	2	2	2	10/100
VT-MIPM-245-D	12	4	8	2	2	2	10/100