

MODEL PAXCDS -SETPOINT OUTPUT OPTION CARDS

DESCRIPTION

This bulletin serves as a guide for the installation of PAX Setpoint cards. The setpoint cards are available as dual relay, quad relay, quad sinking transistor, quad sourcing transistor/SSR drive, or dual triac/dual SSR drive outputs.



INSTALLING A PAXCDS OPTION CARD



Caution: The option and main circuit boards contain static sensitive components. Before handling the cards, discharge static charges from your body by touching a grounded bare metal object. Ideally, handle the circuit boards at a static controlled clean workstation. Dirt, oil or other contaminants that may contact the circuit boards can adversely affect circuit operation.



Warning: Exposed line voltage may be present on the circuit boards when power is applied. Remove all power to the unit AND load circuits before accessing the unit.

- When handling the main circuit board, hold it by the rear cover. When handling the output card, hold it by the terminal block.
- Remove the main assembly from the rear of the case by squeezing both finger holds on the rear cover and pulling the assembly out of the case. Or use a small screwdriver to depress the side latches and pull the main assembly out of the case. Do not remove the rear cover from the main circuit board.
- Install the output card by locating the PAXCDS output card slot location on the main circuit board. Align the option card terminal block with slot # 3 terminal block position of the rear cover. Align the PAXCDS connector with the main circuit board option card connector and then press to fully engage the connectors. Verify that the tab on the option card rests in the alignment slot on the display board.
- If installing a PAXCDS60 option card; a knock-out on the top of the PAX case will need to be removed to allow the PAXCDS60 top terminal block to be inserted later. Locate the  shaped knock-out, positioned at the Setpoint Option, Option Slot 3, location. When looking at the case from the back with knock-outs on top, it is the  shaped knock-out on the right. Carefully remove the knock-out, being careful not to remove any additional knock-outs. Trim any knock-out tabs (gates) that remain on the case. Complete Step 5 and then plug the PAXCDS60 top terminal into the PAXCDS60.
- Slide the assembly back into the case. Be sure the rear cover latches fully engage in the case.
- Apply the option card label to the bottom side of the unit. **Do not cover the vents on the top surface of the unit.** The surface of the case must be clean for the label to adhere properly. Apply the label to the area designated by the large case label.

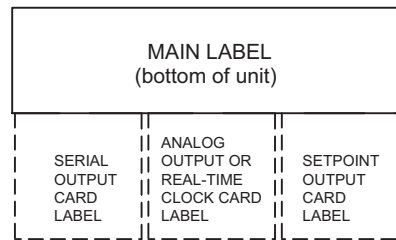
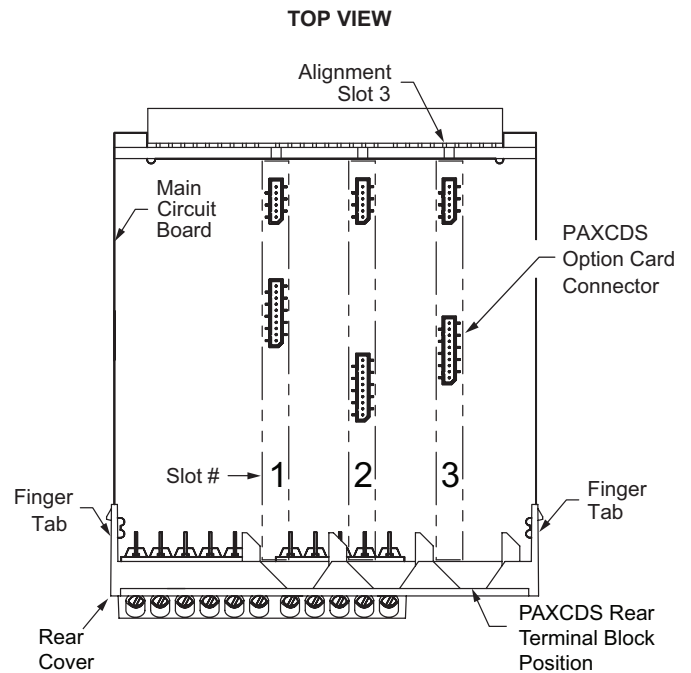

PAXCDS TERMINAL CONNECTIONS

QUAD FORM C RELAY
PAXCDS60

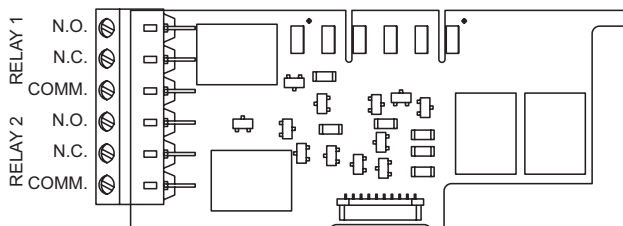
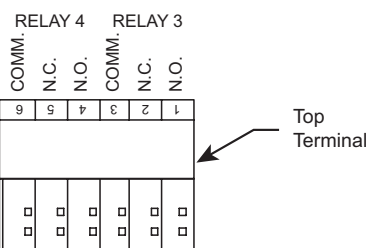

DUAL RELAY
PAXCDS10

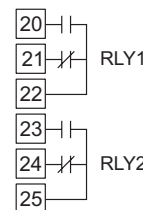

QUAD RELAY
PAXCDS20

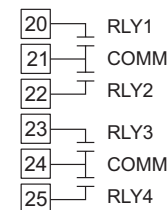

QUAD SINKING
PAXCDS30

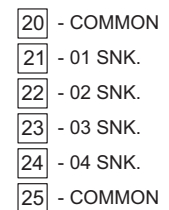

QUAD SOURCING/SSR DRIVE
PAXCDS40

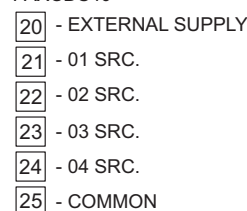

DUAL TRIAC/DUAL SSR DRIVE
PAXCDS50

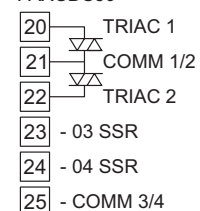

SPECIFICATIONS

Setpoint Output Cards: Six types of field installable cards

Response Time: 200 msec. max. to within 99% of final readout value (digital filter and internal zero correction disabled) 700 msec. max. (digital filter disabled, internal zero correction enabled)
 PAXH only: 1 sec. max. to within 99% of final readout value (digital filter disabled)

PAXT only: 200 msec. typ.; 700 msec max. (digital filter disabled)

PAXH Isolation For All Four Cards:

Isolation To Sensor Common: 1400 Vrms for 1 min.
 Isolation To User Input Common: 500 Vrms for 1 min.

Dual Relay Card: PAXCDS10

Type: Two FORM-C relays
 Isolation To Sensor & User Input Commons: 2000 Vrms for 1 min.
 Contact Rating:
 One Relay Energized: 5 amps @ 120/240 VAC or 28 VDC (resistive load).

Total Current With Both Relays Energized not to exceed 5 amps
 Life expectancy: 100 K cycles min. at full load rating. External RC snubber extends relay life for operation with inductive loads

Quad Form A Relay Card: PAXCDS20

Type: Four FORM-A relays
 Isolation To Sensor & User Input Commons: 2300 Vrms for 1 min.
 Contact Rating:

One Relay Energized: 3 amps @ 250 VAC or 30 VDC (resistive load).
 Total Current With All Four Relays Energized not to exceed 4 amps
 Life Expectancy: 100 K cycles min. at full load rating. External RC snubber extends relay life for operation with inductive loads

Quad Sinking Open Collector Card: PAXCDS30

Type: Four isolated sinking NPN transistors.
 Isolation To Sensor & User Input Commons: 500 Vrms for 1 min.
 Not Isolated from all other commons.

Rating: 100 mA max @ $V_{SAT} = 0.7$ V max. $V_{MAX} = 30$ V

Quad Sourcing Open Collector/SSR Drive Card: PAXCDS40

Type: Four isolated sourcing PNP transistors.
 Isolation To Sensor & User Input Commons: 500 Vrms for 1 min.
 Not Isolated from all other commons.

Rating:
 Internal supply: 18/24 VDC (unit dependent) $\pm 10\%$, 30 mA max. total all four outputs

External supply: 30 VDC max., 100 mA max each output

Dual Triac/Dual SSR Drive Card: PAXCDS50

Triac:
 Type: Isolated, zero crossing detection
 Voltage: 260 VAC max., 20 VAC min.
 Max Load Current: 1 Amp @ 25°C
 0.75 Amp @ 50°C

Total load current with both triacs ON not to exceed 1.5 Amps

Min Load Current: 5 mA

Off State Leakage Current: 1 mA max @ 60 Hz

Operating Frequency: 20-400 Hz

SSR Drive:

Type: Two isolated sourcing PNP Transistors.
 Isolation To Sensor & User Input Commons: 500 Vrms for 1 min.
 Not Isolated from all other commons.

Rating:
 Output Voltage: 18/24 VDC (unit dependent) $\pm 10\%$, 30 mA max. total both outputs

Quad Form C Relay Card: PAXCDS60

Type: Four FORM-C relays
 Isolation To Sensor & User Input Commons: 500 Vrms for 1 min.
 Contact Rating:
 Rated Load: 3 Amp @ 30 VDC/125 VAC
 Total Current With All Four Relays Energized not to exceed 4 amps
 Life Expectancy: 100 K cycles min. at full load rating. External RC snubber extends relay life for operation with inductive loads

Quad Sourcing Open Collector Output Card Supply Select

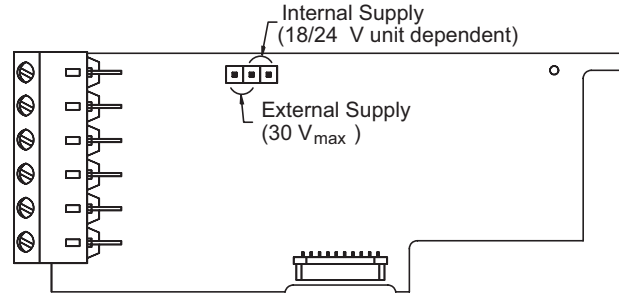

For Quad Sourcing/SSR Drive Option Card (PAXCDS40), set the jumper for internal or external supply operation before applying power.

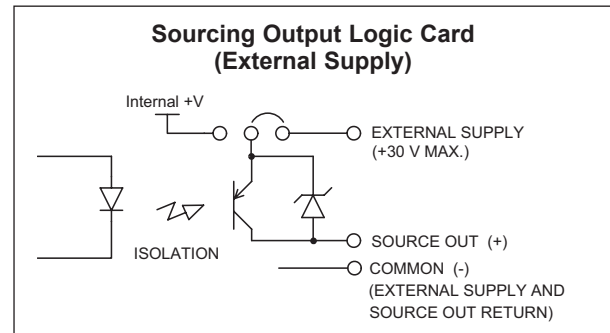
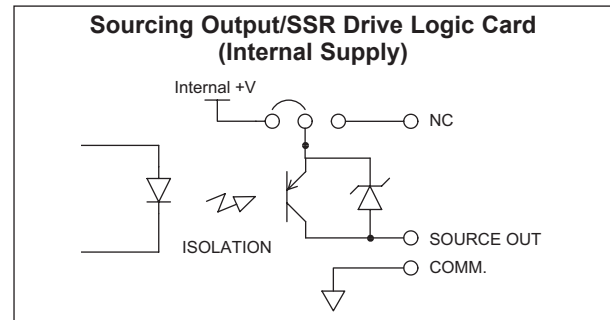

ORDERING INFORMATION

MODEL NO.	DESCRIPTION	PART NUMBER
PAXCDS	Dual Relay Output Card	PAXCDS10
	Quad Form A Relay Output Card	PAXCDS20
	Quad Sinking Open Collector Output Card	PAXCDS30
	Quad Sourcing Open Collector/SSR Drive Output Card	PAXCDS40
	Dual Triac/Dual SSR Drive Output Card	PAXCDS50
	Quad Form C Relay Output Card	PAXCDS60 *

* This card is not suitable for use in older PAX models. For proper installation, a case knock-out feature must be present on the top surface of the PAX case. This feature began to be introduced to the standard PAX units in July of 2014 (2614).

RED LION CONTROLS TECHNICAL SUPPORT

If for any reason you have trouble operating, connecting, or simply have questions concerning your new product, contact Red Lion's technical support.

Support: support.redlion.net

Website: www.redlion.net

Inside US: +1 (877) 432-9908

Outside US: +1 (717) 767-6511

Red Lion Controls, Inc.
 20 Willow Springs Circle York, PA 17406

COPYRIGHT

©2022 Red Lion Controls, Inc. All rights reserved. Red Lion and the Red Lion logo are trademarks of Red Lion Controls, Inc. All other company and product names are trademarks of their respective owners.