

SPECIFICATION

- Part No. : **MA741.B.BI.001**
- Product Name : Pantheon Antenna 2in1 MA.741
LTE Cellular 4G/3G 2*2 MIMO
Screw-Mount (Permanent Mount)
- Feature : **2 x LTE Cellular (2G/3G/4G) Antennas (MIMO)**
Works for LTE/GSM/GPRS/CDMA/UMTS/HSPA
698~960MHz, 1710~2170MHz, 2300~2700MHz
IP67 Waterproof
High Efficiency / Peak Gain Outdoor Antenna
3M CFD-200 SMA(M)
RoHS Compliant



1. Introduction

The MA741 Pantheon LTE 4G MIMO 2*2 antenna is an omnidirectional, heavy-duty, fully IP67 waterproof external M2M antenna for use in telematics, transportation, and remote monitoring applications. It includes two LTE MIMO antennas with the highest efficiency and peak gain possible. This is necessary for today's high speed data uplink and downlink systems in applications such as real time video, for maximum throughput and highest signal-to-noise ratio.

The antenna elements operate at all common 2G, 3G, and 4G LTE bands worldwide 698-960MHz, 1710-2170MHz, 2300~2700MHz.

The housing is an extremely robust IP67 direct mount antenna package with excellent isolation (10dB+). The antenna has its own ground-plane and can radiate on any mounting environment like metal or plastic without affecting performance. For cable length requests above 5 metres contact Taoglas for advice about suitability for application.

The connectors and cable length are customizable. The enclosure is also available in White, MA741.W.B.BI.001.

2. Specification Table

2G/3G/4G MIMO1									
	XIII, 17 (NA)	XX (EU)	V (NA)	VIII (EU)	III (EU)	II (NA)	IV (NA)	I (EU)	VII (EU)
Frequency	698-803	791-862	824-894	880-960	1710-1880	1850-1990	1710-2155	1920-2170	2500-2690
Peak Gain	4.16	2.47	2.47	2.58	1.54	2.31	2.31	2.24	3.01
Efficiency	62.41	58.02	61.74	58.56	55.45	63.19	59.89	63.93	56.19
Average Gain	-2.08	-2.39	-2.10	-2.34	-2.56	-2.00	-2.24	-1.95	-2.51
Return Loss	<-6								
Polarization	Vertical								
Impedance	50								
2G/3G/4G MIMO2									
	XIII, 17 (NA)	XX (EU)	V (NA)	VIII (EU)	III (EU)	II (NA)	IV (NA)	I (EU)	VII (EU)
Frequency	698-803	791-862	824-894	880-960	1710-1880	1850-1990	1710-2155	1920-2170	2500-2690
Peak Gain	2.95	2.13	2.08	2.01	2.02	2.58	2.58	2.58	3.40
Efficiency	61.03	56.79	58.01	52.35	55.11	63.06	59.74	64.13	58.27
Average Gain	-2.17	-2.47	-2.37	-2.82	-2.59	-2.01	-2.25	-1.93	-2.35
Return Loss	<-6								
Polarization	Vertical								
Impedance	50								
MECHANICAL									
Antenna Dimensions	Height 85.7mm x Diameter 145.6mm								
Casing	Wonderloy PC-540 PC/ABS Alloy								
Waterproof	IP67								
Weight	1.16kg/1pcs								
Recommended Torque for Mounting	49N·m								
Max Torque for Mounting	58.8N·m								
2G/3G/4G MIMO 1	3M CFD-200 SMA(M)								
2G/3G/4G MIMO 2	3M CFD-200 SMA(M)								
ENVIRONMENTAL									
Operation Temperature	-40°C to 85°C								
Storage Temperature	-40°C to 85°C								
Humidity	Non-condensing 65°C 95% RH								

* All measurements were conducted with 3M CFD200 cable

LTE BANDS				
Band Number	LTE/LTE- Advanced /WCDMA/HSPA.HSPA+			
	Uplink	Downlink	MIMO 1	MIMO 2
1	UL: 1920 to 1980	DL: 2110 to 2170	✓	✓
2	UL: 1850 to 1910	DL: 1930 to 1990	✓	✓
3	UL: 1710 to 1785	DL: 1805 to 1880	✓	✓
4	UL: 1710 to 1755	DL: 2110 to 2155	✓	✓
5	UL: 824 to 849	DL: 869 to 894	✓	✓
7	UL: 2500 to 2570	DL:2620 to 2690	✓	✓
8	UL: 880 to 915	DL: 925 to 960	✓	✓
9	UL: 1749.9 to 1784.9	DL: 1844.9 to 1879.9	✓	✓
11	UL: 1427.9 to 1447.9	DL: 1475.9 to 1495.9	✗	✗
12	UL: 699 to 716	DL: 729 to 746	✓	✓
13	UL: 777 to 787	DL: 746 to 756	✓	✓
14	UL: 788 to 798	DL: 758 to 768	✓	✓
17	UL: 704 to 716	DL: 734 to 746 (LTE only)	✓	✓
18	UL: 815 to 830	DL: 860 to 875 (LET only)	✓	✓
19	UL: 830 to 845	DL: 875 to 890	✓	✓
20	UL: 832 to 862	DL: 791 to 821	✓	✓
21	UL: 1447.9 to 1462.9	DL: 1495.9 to 1510.9	✗	✗
22	UL: 3410 to 3490	DL: 3510 to 3590	✗	✗
23	UL:2000 to 2020	DL: 2180 to 2200 (LTE only)	✓	✓
24	UL:1625.5 to 1660.5	DL: 1525 to 1559 (LTE only)	✓	✓
25	UL: 1850 to 1915	DL: 1930 to 1995	✓	✓
26	UL: 814 to 849	DL: 859 to 894	✓	✓
27	UL: 807 to 824	DL: 852 to 869 (LTE only)	✓	✓
28	UL: 703 to 748	DL: 758 to 803 (LTE only)	✓	✓
29	UL: -	DL: 717 to 728 (LTE only)	✓	✓
30	UL: 2305 to 2315	DL: 2350 to 2360 (LTE only)	✓	✓
31	UL: 452.5 to 457.5	DL: 462.5 to 467.5 (LTE only)	✗	✗
32	UL: -	DL: 1452 - 1496	✗	✗
35		1850 to 1910	✓	✓
38		2570 to 2620	✓	✓
39		1880 to 1920	✓	✓
40		2300 to 2400	✓	✓
41		2496 to 2690	✓	✓
42		3400 to 3600	✗	✗
43		3600 to 3800	✗	✗

3. LTE MIMO

3.1. LTE MIMO 1 and LTE MIMO 2 Specification

3.1.1. Return Loss and Isolation

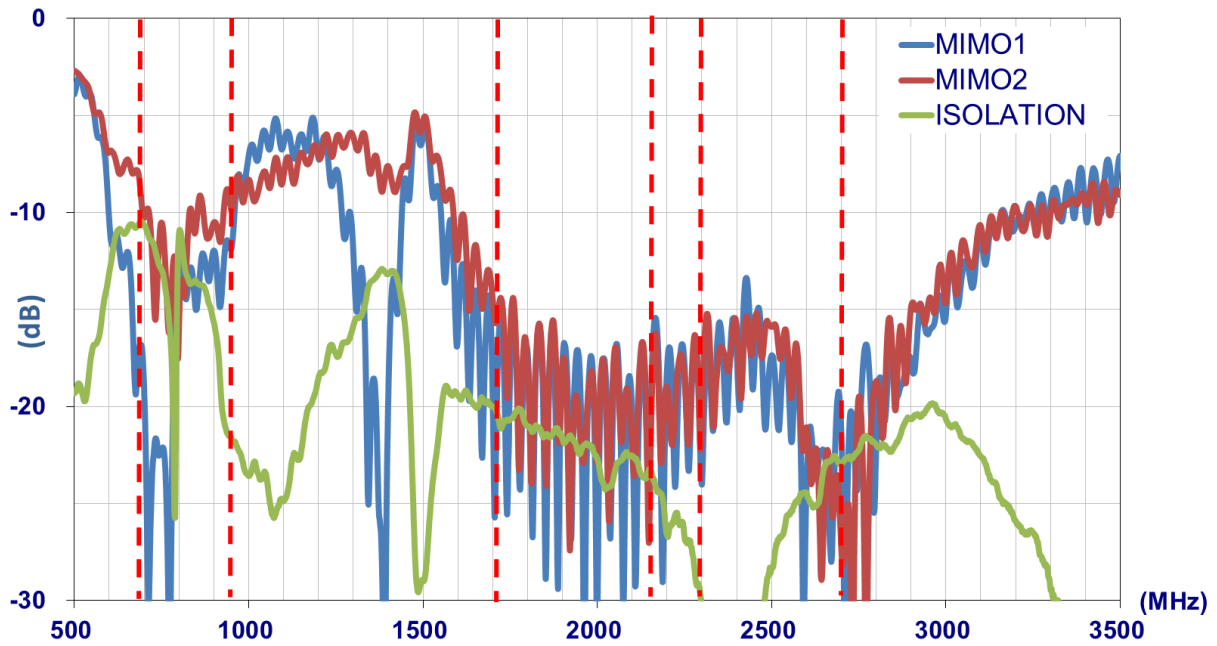

3.1.2. Peak Gain

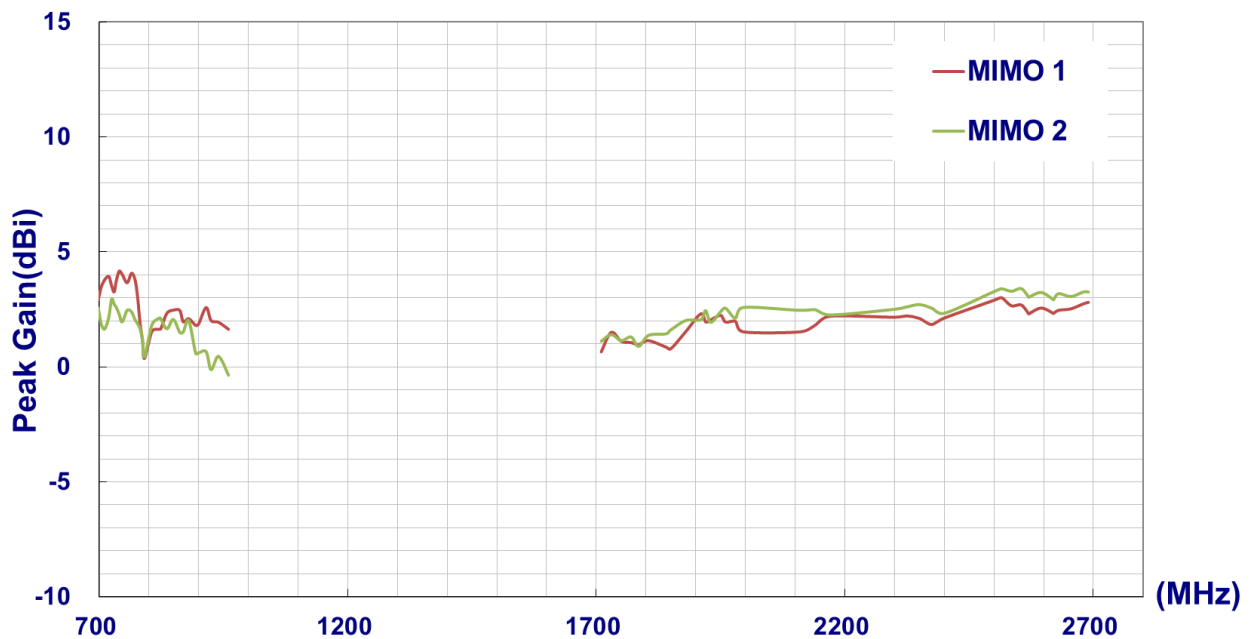

3.1.3. Average Gain

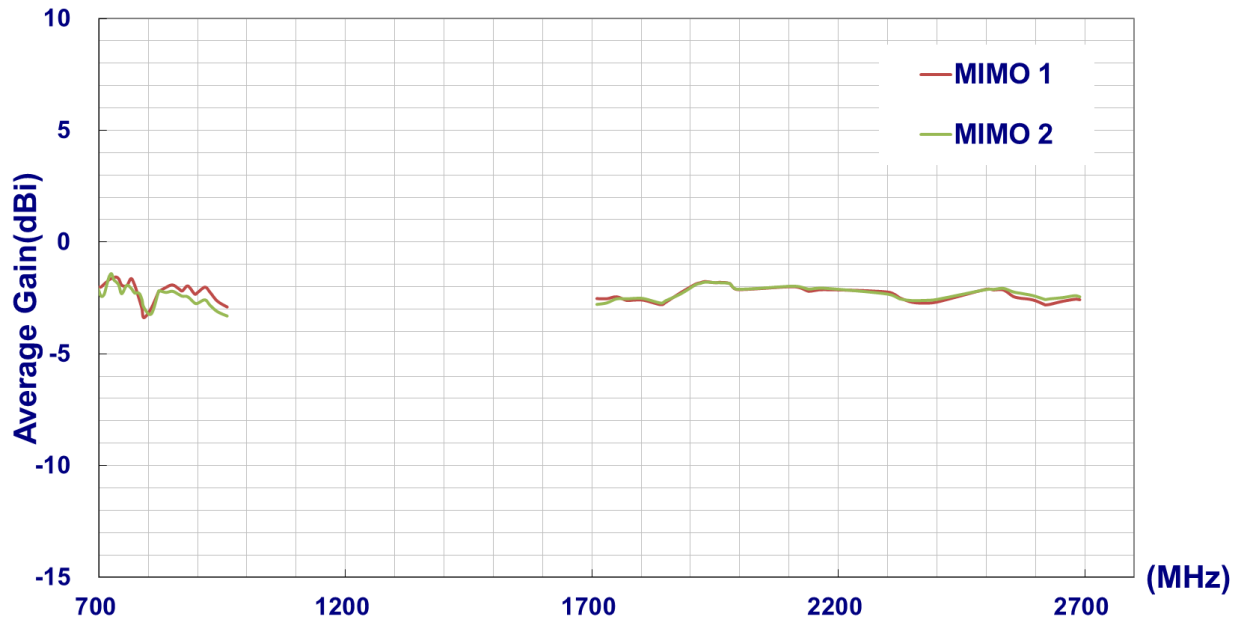

3.1.4. Efficiency

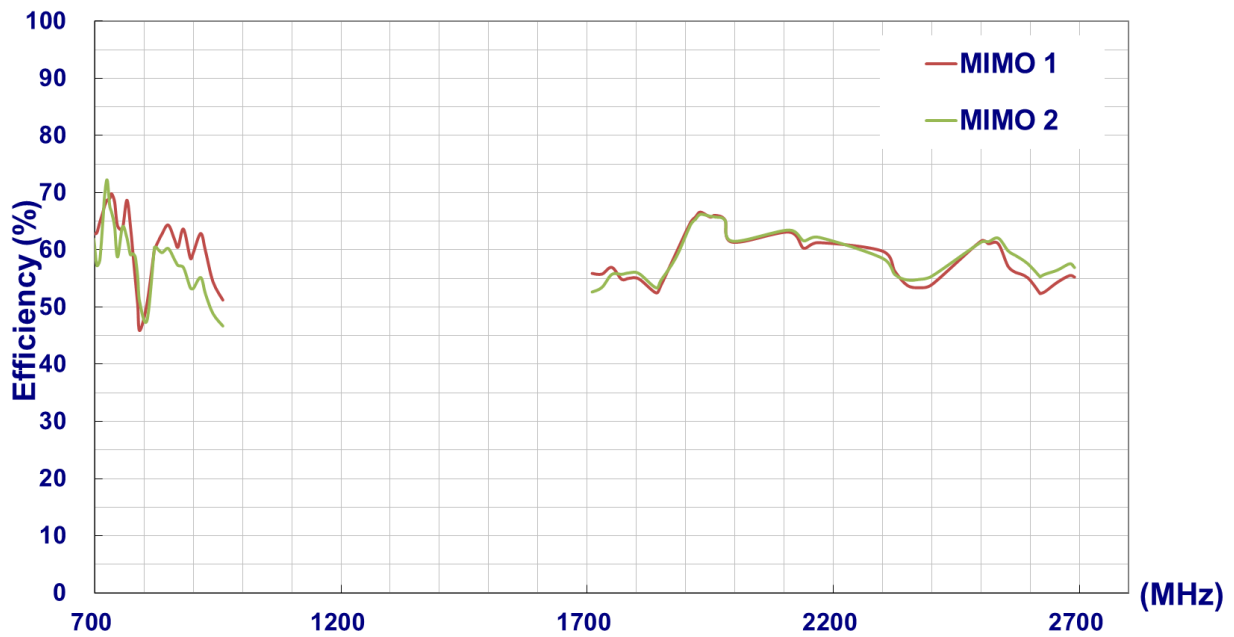

3.2 Radiation Patterns

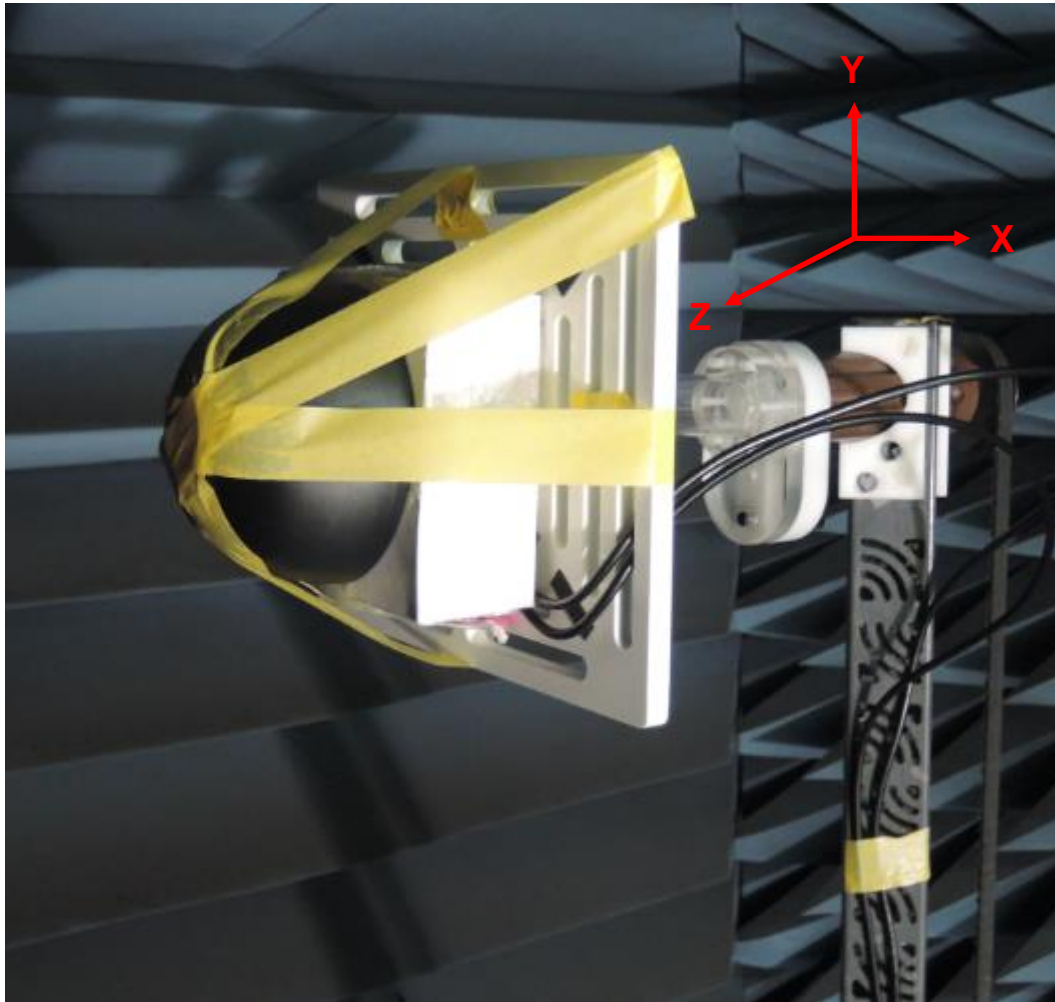

3.2.1 LTE MIMO 1 Radiation Pattern

XY plane

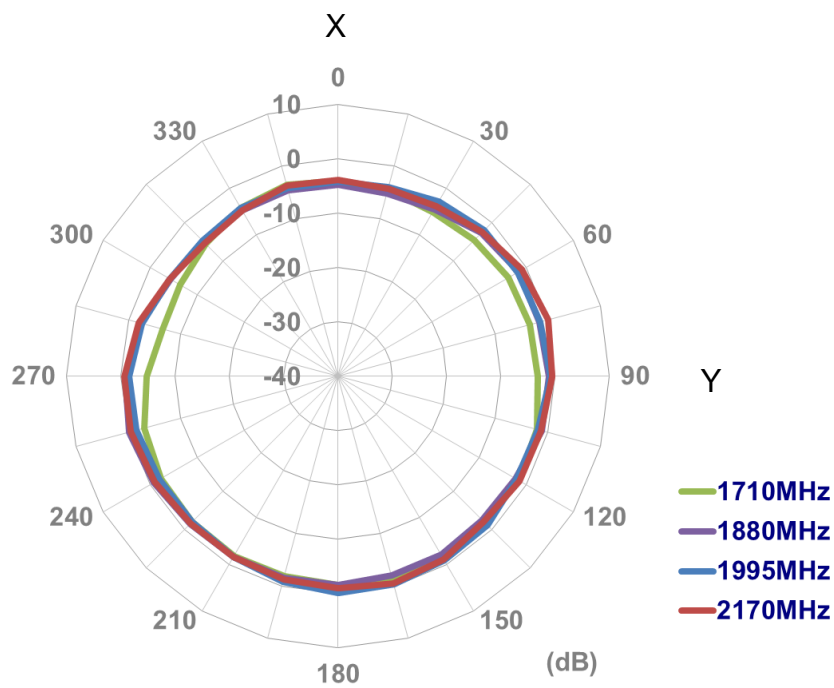
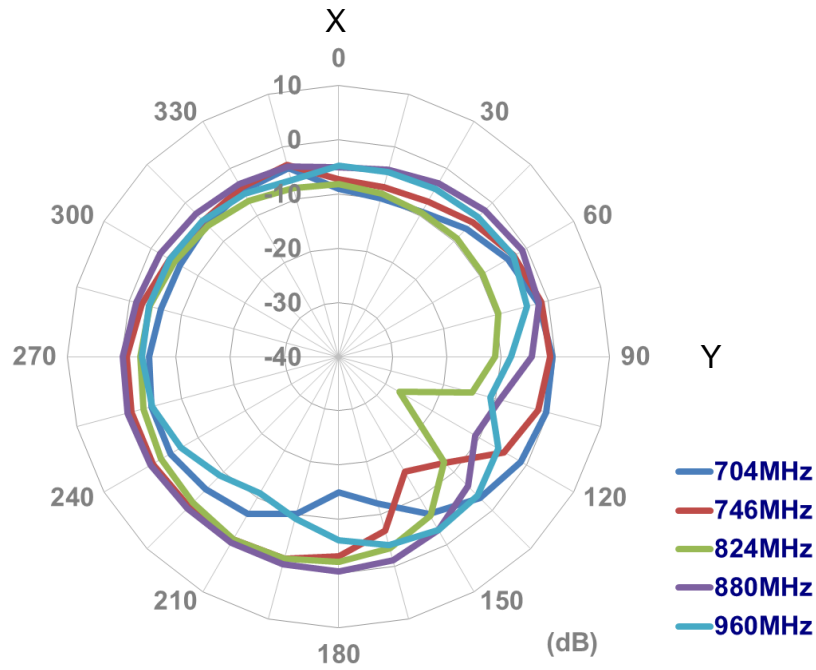

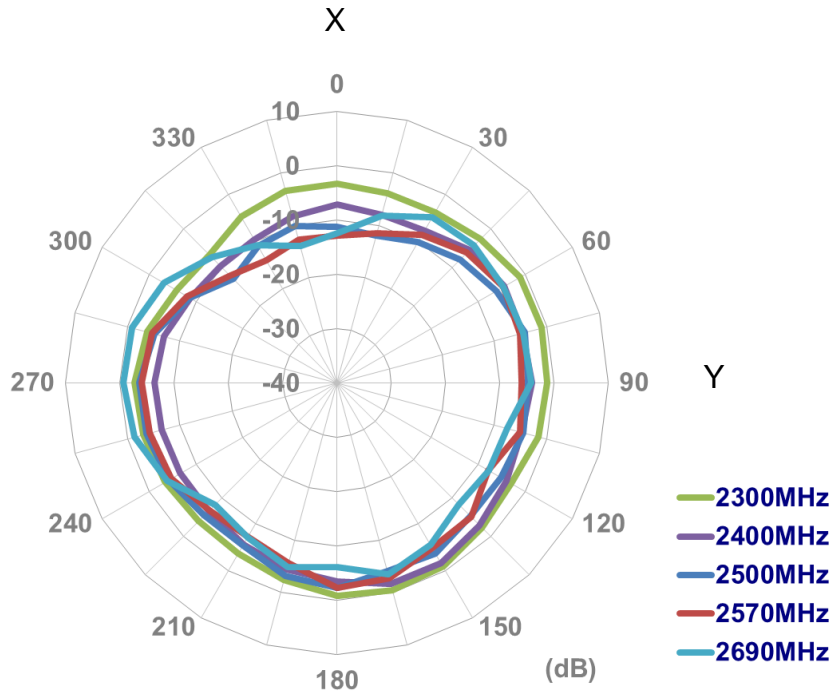

XZ plane

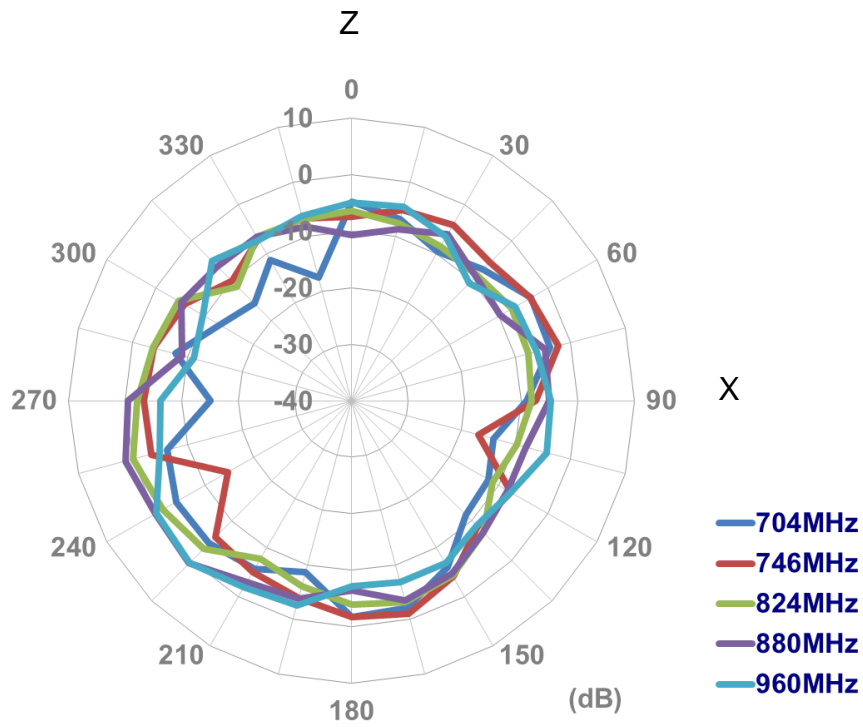

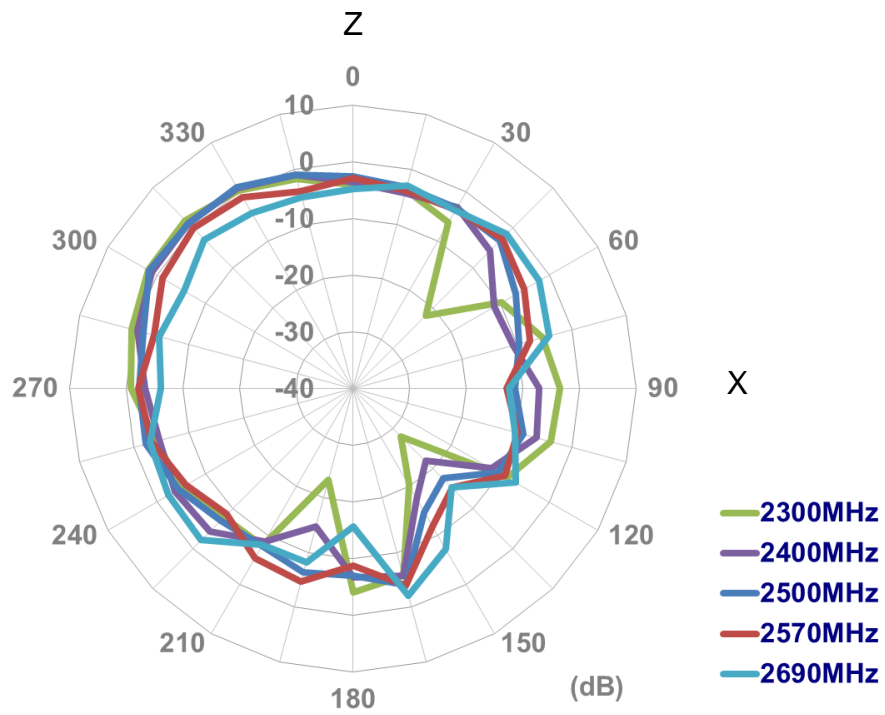
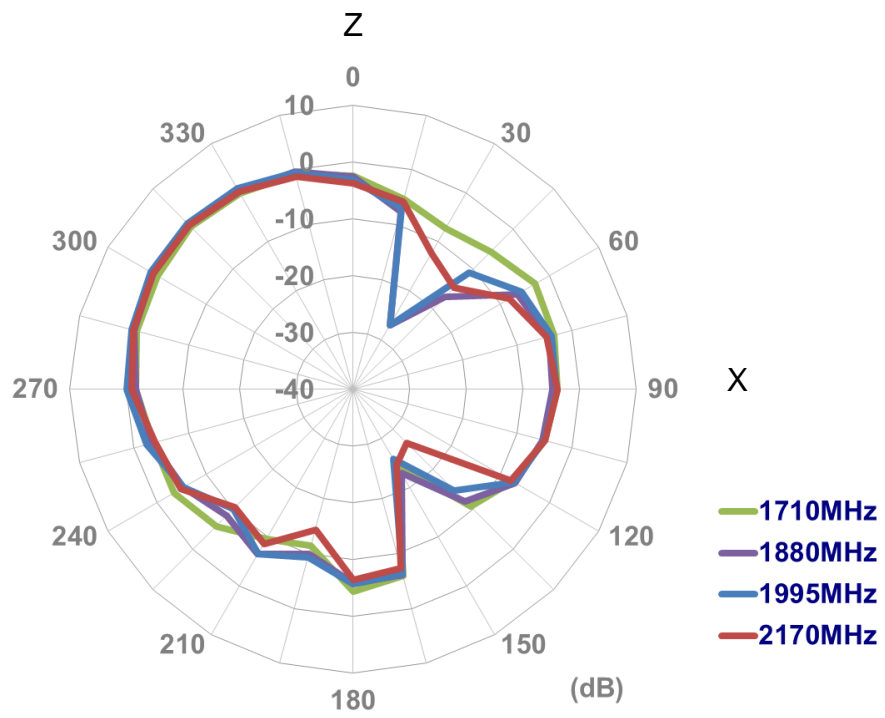

YZ plane

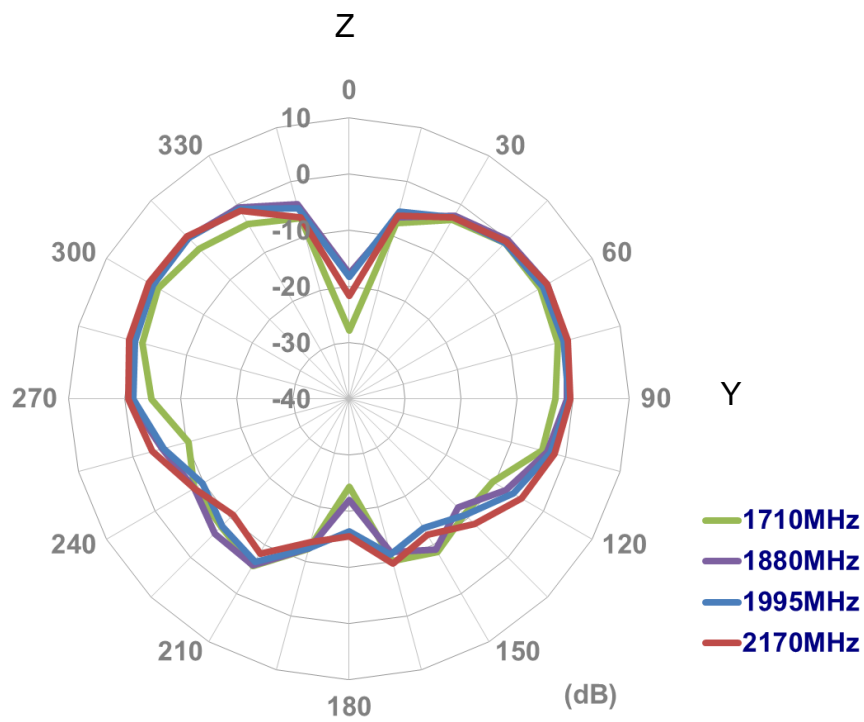
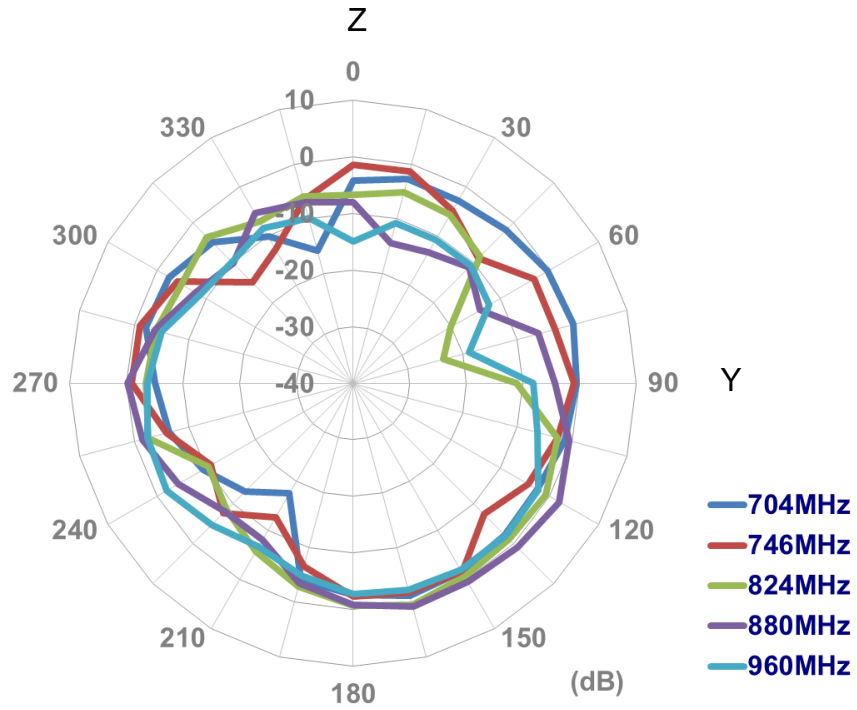

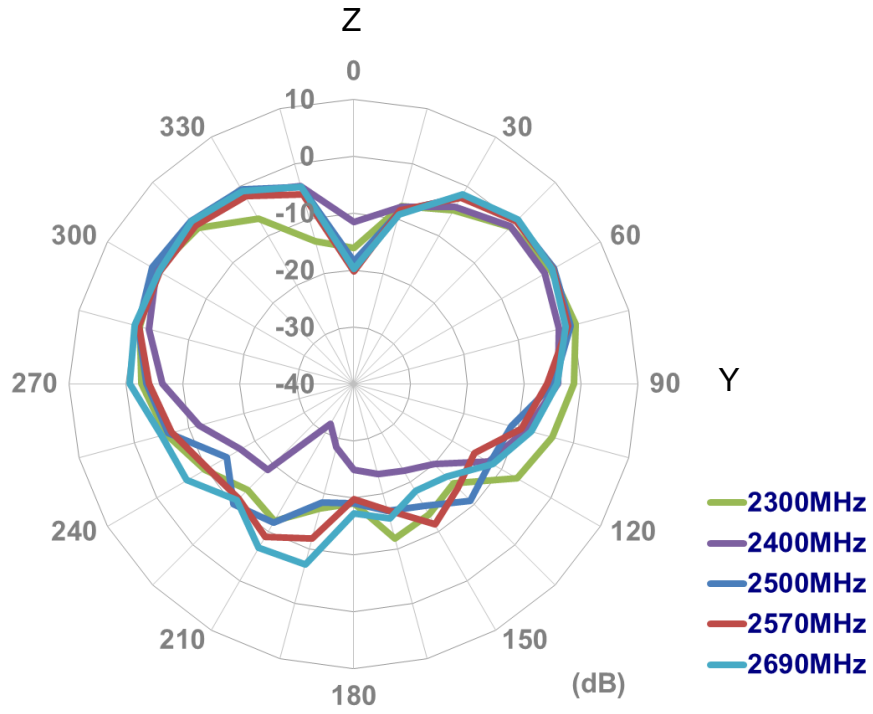

3.2.2 LTE MIMO 2 Radiation Pattern

XY plane

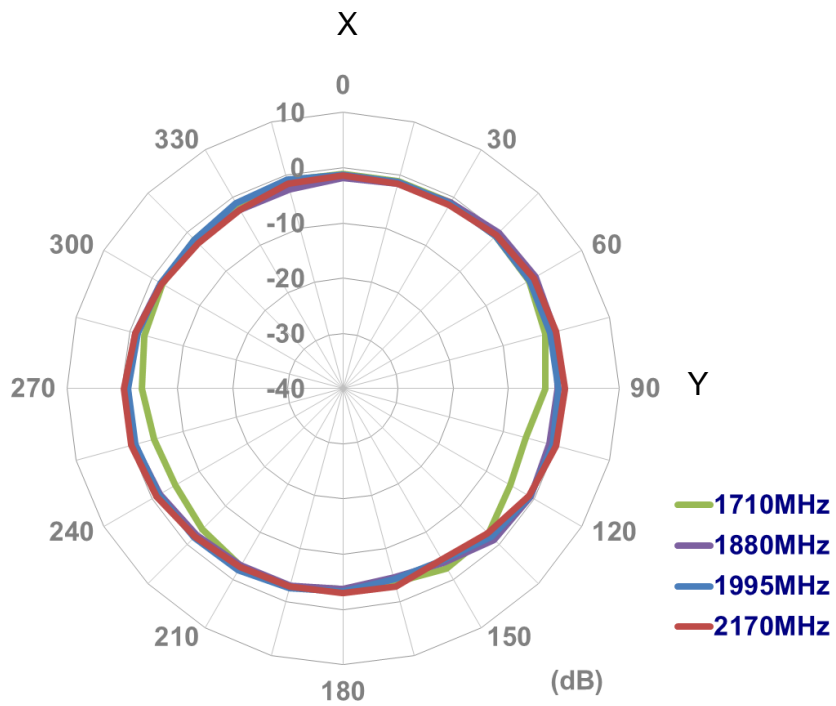
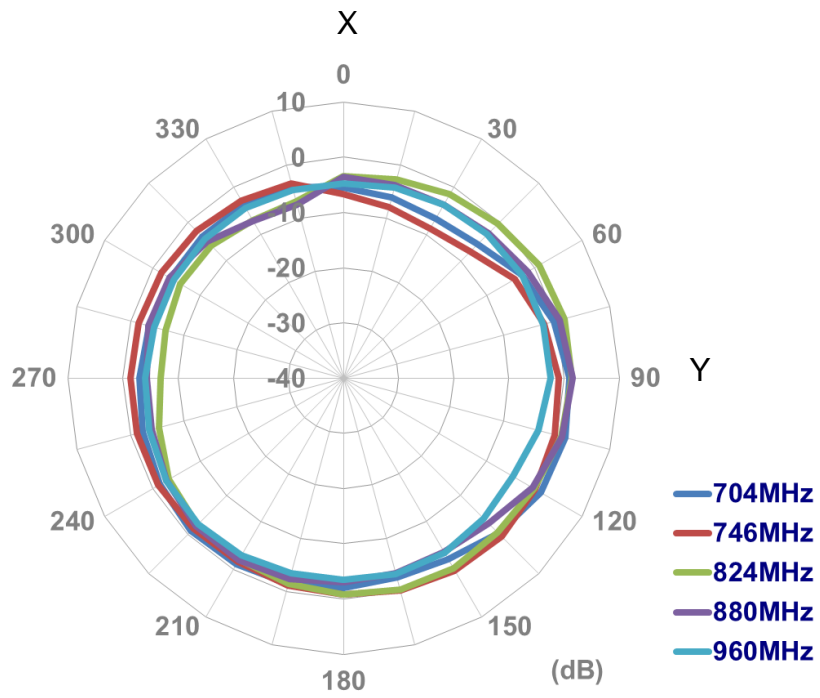

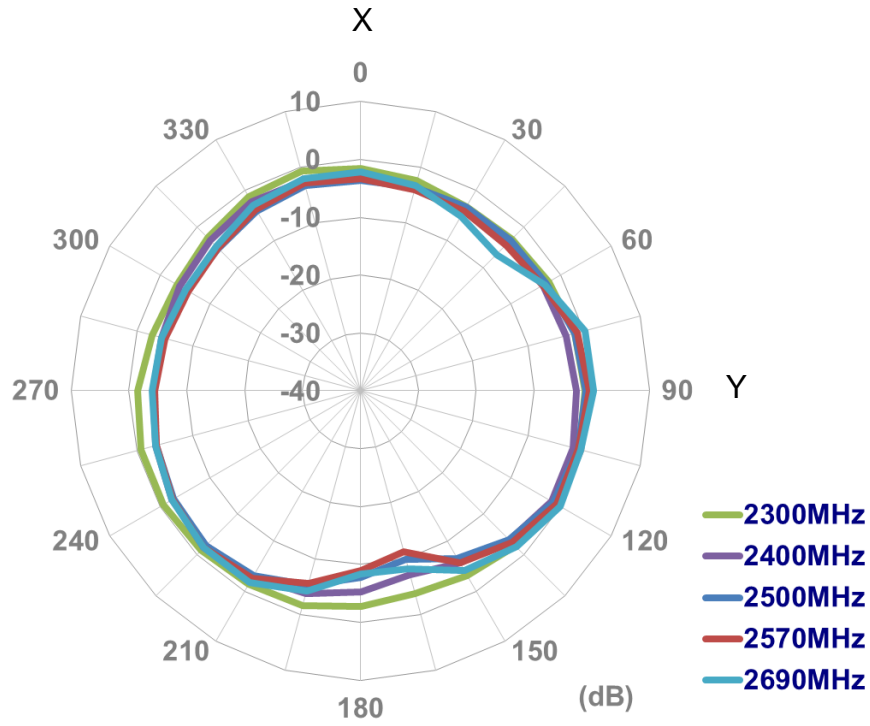

XZ plane

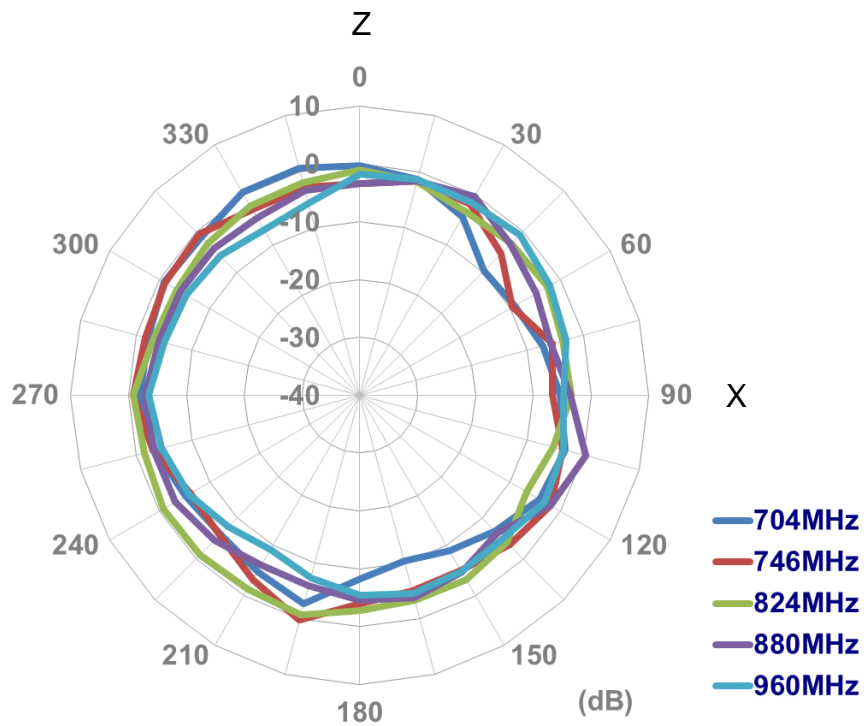

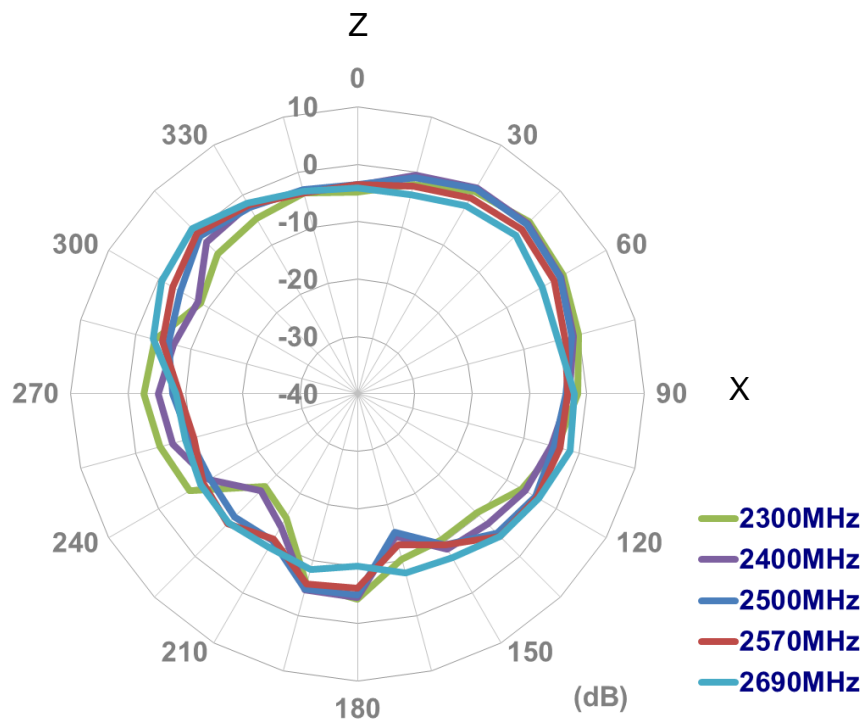
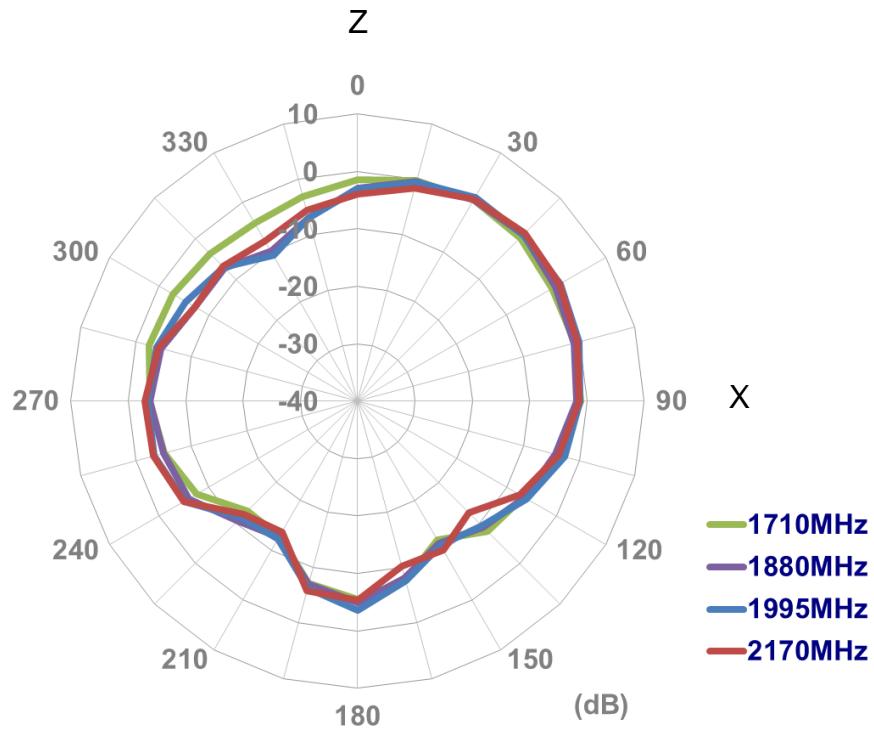

YZ plane

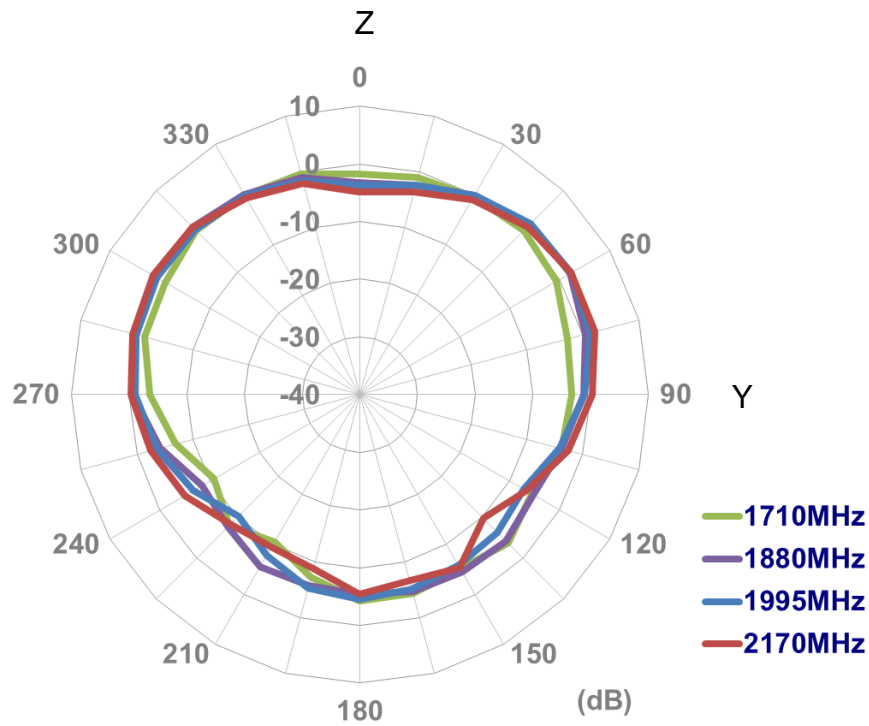
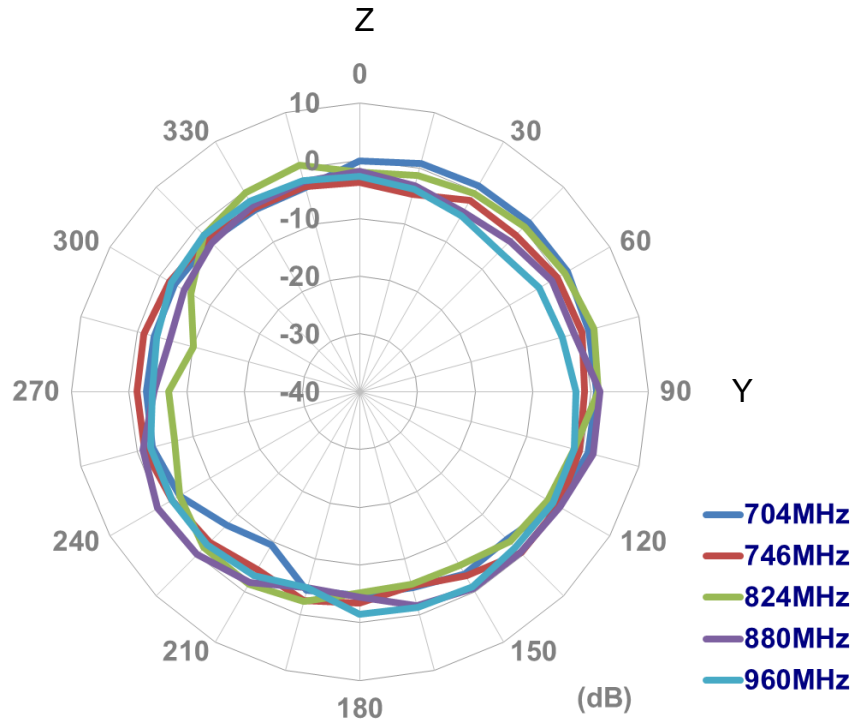

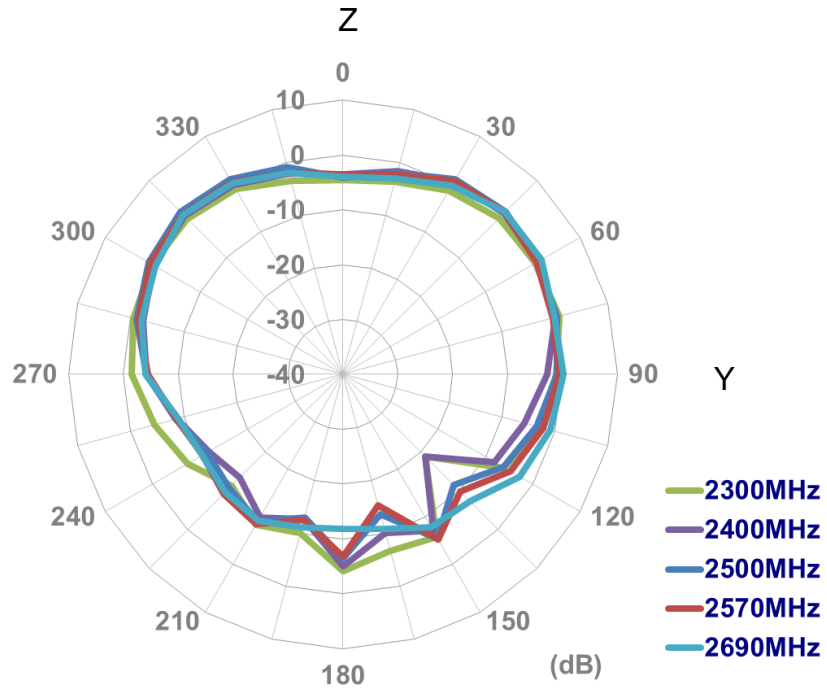

4. Drawing

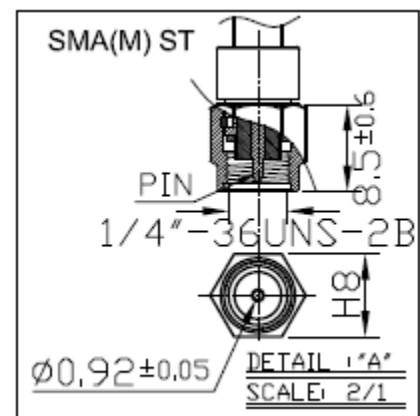
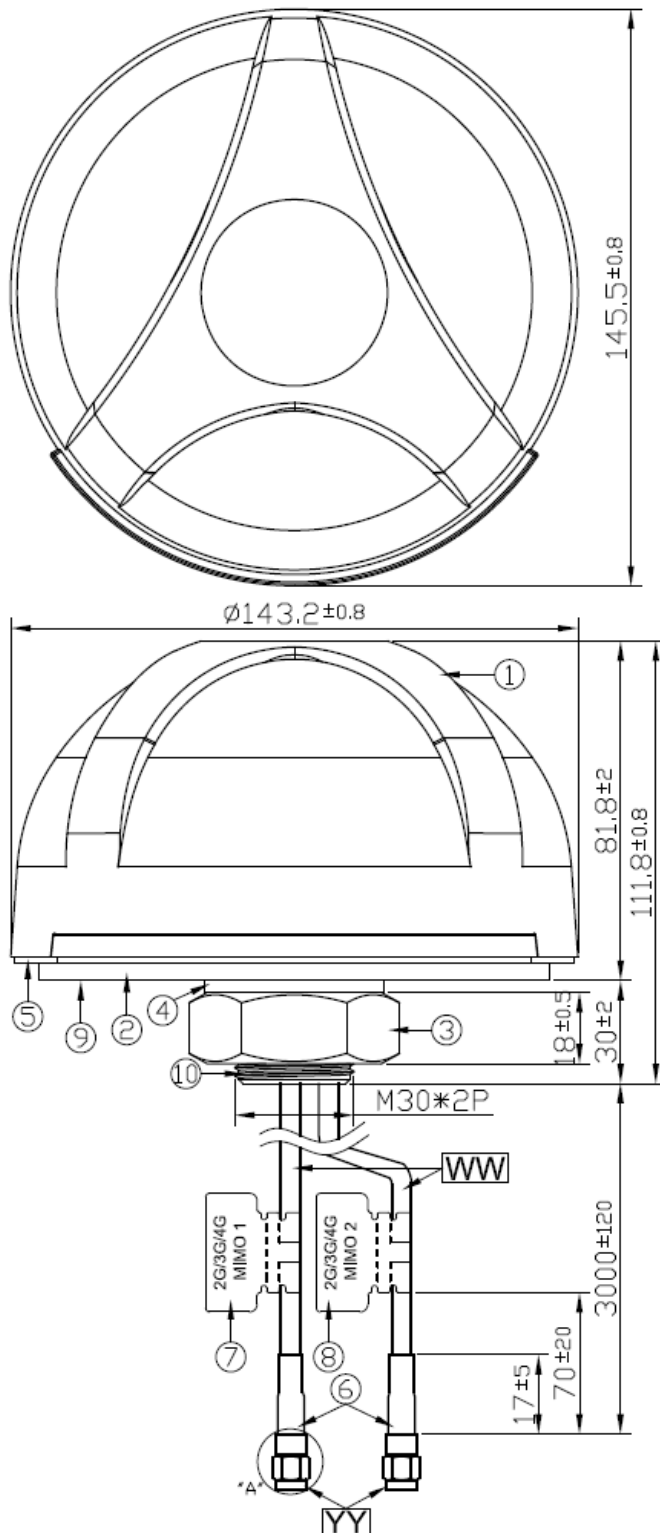

	Name	Material	Finish	QTY
1	Housing	PC 540	Black	1
2	Closed Cell Foam	CR 4305	Black	1
3	M30 Nut	Steel AISI 1215	Ni Plated	1
4	Washer	Steel AISI 1215	Ni Plated	1
5	Waterproof Gasket	Silicon Rubber	Black	1
6	Heat Shrink Tube	PE	Black	1
7	2G/3G/4G MIMO1 Label	Coated Paper	Gray	1
8	2G/3G/4G MIMO2 Label	Coated Paper	White	1
9	3M Double Adhesive	3M 9448 HK	White Liner	1
10	M30x 2 Thread 32L	Zinc Alloy	NI Plated	1

	Name	Spec	Finish	QTY
WW	Cable Type	CFD200	Black	2
YY	Connector Type	SMA(M) ST	Gold	2

5. Installation

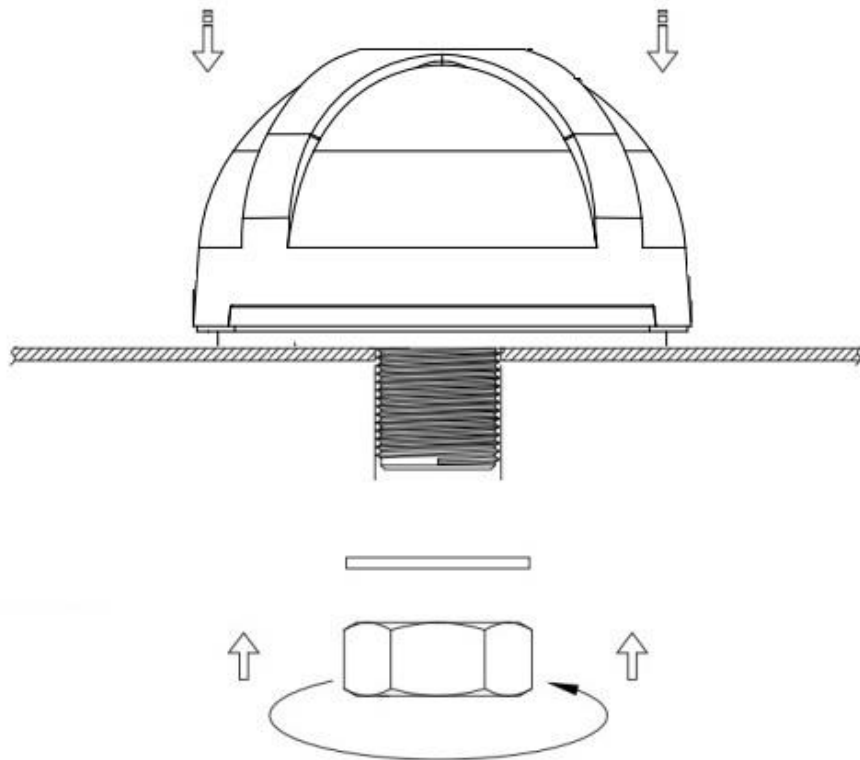

Recommended Torque for Mounting 49 N·m
 Maximum Torque for Mounting 58.8 N·m

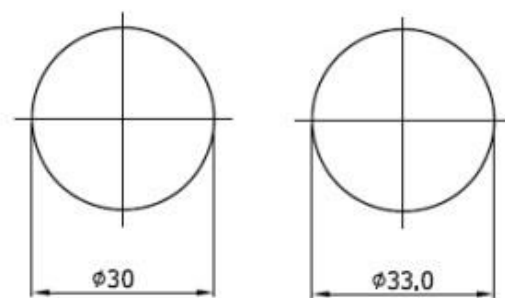

**Thread
 Diameter**

**Recommended
 Mounting Hole**

Unit: mm

6. Packaging

1 MA741.B.BI.001 per box
 Box Dimensions - 185*170*180 mm
 Total Weight - 1.26Kg

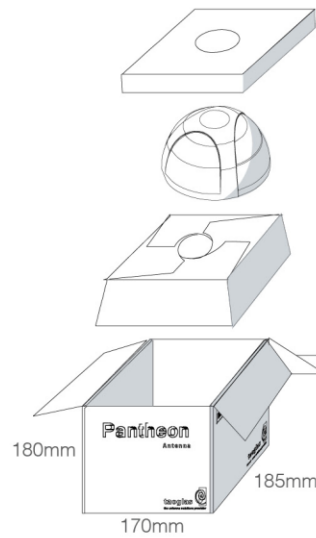

8 boxes per carton
 Carton Dimensions - 380*350*380mm
 Total Weight - 11Kg

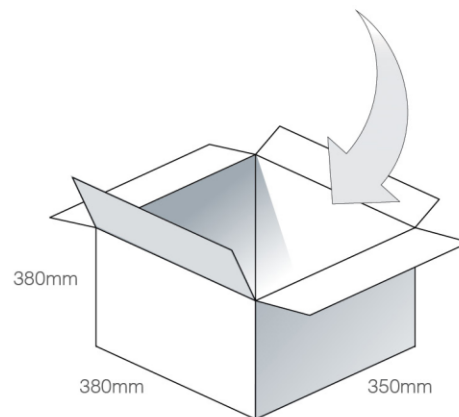

Pallet Dimensions 1100*1100*1290mm
 24 Cartons per pallet
 6 Cartons per layer
 4 Layers

